

# LABORATORY HELIUM NEON LASER POWER SUPPLY

## MODEL: 06-LPL-900-065

### INPUT SPECIFICATIONS

Voltage (VAC)	110 to 240
Line Frequency (Hz)	50 or 60
Current (A)	0.23 at 115 VAC / 0.12 at 230 VAC

### OUTPUT SPECIFICATIONS

Sustaining Voltage (VDC)	1300 to 1900
Start Voltage (kVDC)	>8
Current Setting (mA)	6.5 ± 0.2
Power (W)	< 12.74
Current Ripple (% Peak to Peak)	< 2.0
Current Ripple (% RMS)	< 1.0
Time Delay (Seconds)	3 to 7

### ENVIRONMENTAL SPECIFICATIONS

### OPERATING

### NON-OPERATING

Temperature (°C)	0 to +50	-40 to +80
Altitude (meters)	0 to 3000	0 to ∞
Relative Humidity (% , non-condensing)	0 to 99%	0 to 99%
Mechanical Shock (g)	< 50 for < 11 msec	< 50 for < 11 msec < 100 for < 1 msec
Agency Approvals		CE

Specifications are subject to change without notice.

\*Please specify AC cord plug type: NEMA 5-15P for 100 to 120VAC, Schuko (CEE7/4) for 230VAC, or BS 1363 for 230 or 240VAC.

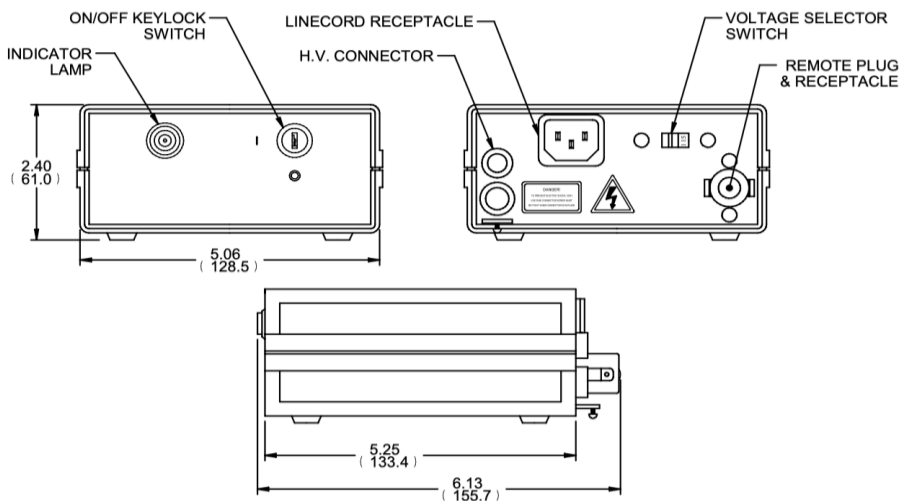

Dimensions in Inches (mm)  
Reference Dimensions Only

© Pacific Lasertec, LLC. All Rights Reserved



Rev 6.21.3