

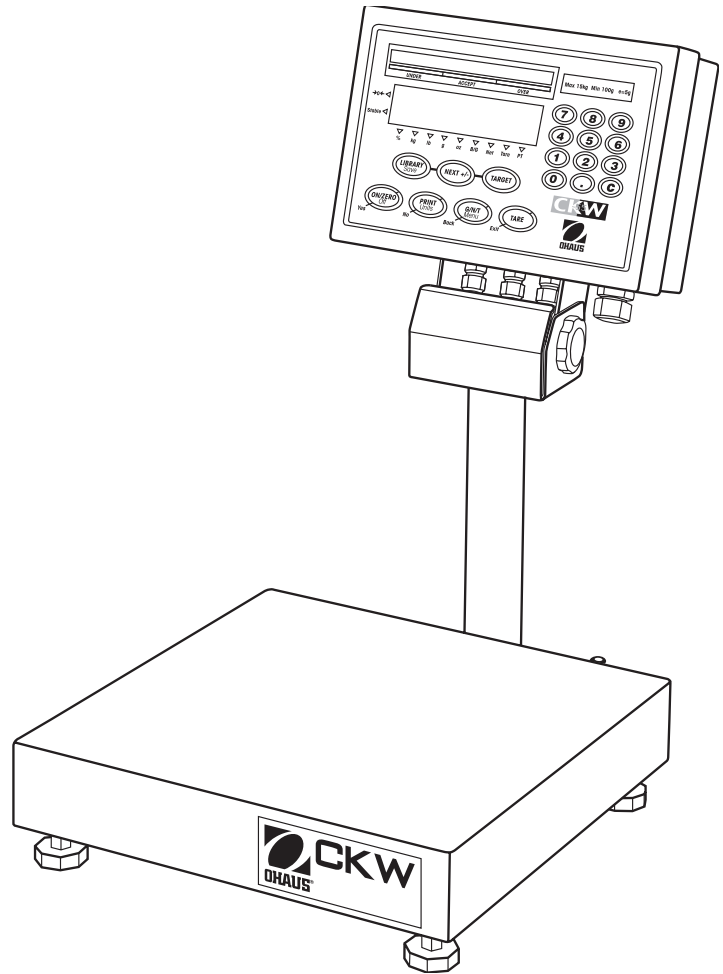

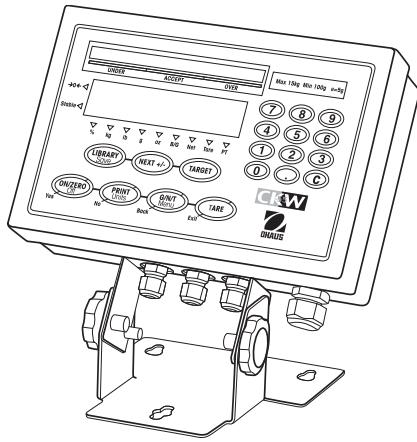

CKW-55 Indicator and CKW Series Scale Instruction Manual



Declaration of Conformity We, Ohaus Corporation, declare under our sole responsibility that the instruments listed below are in conformity with the directives and standards mentioned.

Model/Type CKW-55, CKW3R55, CKW6R55, CKW15L55, CKW30L55

EC Marking:	EC Directive	Applicable Standards
	EU 73/23/EEC Low Voltage	EN60950-1: 2003
	89/336/EEC Electromagnetic compatibility	EN61326-1:1997 +A1:1998 +A2: 2001
<i>For non-automatic weighing instruments used in an Article 1, 2.(a) application, additional metrological marking according to Annex IV of Council directive 90/384/EEC must be attached to the instrument</i>		
	90/384/EEC Non-Automatic Weighing Instruments	EN45501:1992 1)

1) Valid only for CKW-55 terminals in connection with approved load cells

Date: October 1, 2004







Ted Xia
President
Ohaus Corporation
Pine Brook, NJ USA



Urs Muller
General Manager
Ohaus Europe
Greifensee, Switzerland

Compliance to the following standards is indicated by the corresponding marking on the product.

Marking	Standard
	UL60950-1 : 2003
	AS/NZS4251.1, AS/NZS4252.1
	NSF CRITERIA C-2-1983
	NSF/ANSI /3-A 14159-1 - 2002

FCC Note

This equipment has been tested and found to comply with the limits for a Class B digital device, pursuant to Part 15 of the FCC Rules. These limits are designed to provide reasonable protection against harmful interference in a residential installation. This equipment generates, uses and can radiate radio frequency energy and, if not installed and used in accordance with the instructions, may cause harmful interference to radio communications. However, there is no guarantee that interference will not occur in a particular installation. If this equipment does cause harmful interference to radio or television reception, which can be determined by turning the equipment off and on, the user is encouraged to try to correct the interference by one or more of the following measures:

- Reorient or relocate the receiving antenna.
- Increase the separation between the equipment and receiver.
- Connect the equipment into an outlet on a circuit different from that to which the receiver is connected.
- Consult the dealer or an experienced radio/TV technician for help.

Industry Canada Note

This Class B digital apparatus complies with the Canadian ICES-003.
 Cet appareil numérique de la classe B est conforme à la norme NMB-003 du Canada.

ISO 9001 Registration

In 1994, Ohaus Corporation, USA, was awarded a certificate of registration to ISO 9001 by Bureau Veritas Quality International (BVQI), confirming that the Ohaus quality management system is compliant with the ISO 9001 standard's requirements. On May 15, 2003, Ohaus Corporation, USA, was re-registered to the ISO 9001:2000 standard.

TABLE OF CONTENTS FOR CKW-55 INDICATOR

Page

1.	INTRODUCTION	EN-5
1.1	Description	EN-5
1.2	Features	EN-5
1.3	Safety Precautions.....	EN-6
1.3.1	Relay Option Safety Precautions.....	EN-6
2.	INSTALLATION	EN-7
2.1	Unpacking and Checking	EN-7
2.2	Selecting the Location	EN-7
2.3	Connecting Power	EN-7
2.3.1	AC Power.....	EN-7
2.3.2	Battery Power (Optional Equipment)	EN-7
2.4	Initial Calibration	EN-8
3.	OPERATION	EN-8
3.1	Overview of Parts and Controls.....	EN-8
3.2	Control Functions	EN-10
3.3	Menu	EN-11
3.3.1	Menu Structure	EN-11
3.3.2	Menu Navigation	EN-12
3.4	Turning Indicator On/Off	EN-12
3.4.1	Turning On	EN-12
3.4.2	Turning Off.....	EN-12
3.4.3	Stabilization.....	EN-12
3.5	Application Modes	EN-13
3.5.1	Weighing.....	EN-13
	Zero Operation	EN-13
	Basic Weighing	EN-13
	Manual Tare	EN-13
	Preset Tare.....	EN-13
	Auto-Tare.....	EN-14
	Auto-Tare Accept.....	EN-14
	Displaying Gross, Net, Tare	EN-14
	Changing Units of Measure.....	EN-14
	Printing Data	EN-14
	Accumulation Operation	EN-15
3.5.2	Checkweighing	EN-16
	Bar Graph, Beeper and Weight Display Indication	EN-16
	Summary of Checkweigh Key Functions.....	EN-16
	Programming Accept Range by Numeric Key Entry	EN-17
	Programming Target, Minimum and Maximum Variance Values	EN-18
	Programming Target and Minimum and Maximum % Variance	EN-19

TABLE OF CONTENTS FOR CKW-55 INDICATOR (Cont.)		Page
	Normal Checkweighing Operation	EN-20
	Negative Checkweighing Operation	EN-20
	Zero Checkweighing Operation	EN-21
3.5.3	Library Operation	EN-22
	Summary of Library Key Functions	EN-22
	Entering and Editing Library Data	EN-22
	Loading an Existing Library to the Active Checkweigh Mode	EN-24
	Reviewing Library Data	EN-25
3.6	Scale Settings	EN-25
3.6.1	Setup Menu	EN-25
3.6.2	Readout Menu	EN-27
3.6.3	Mode Menu	EN-28
3.6.4	Print Menu	EN-31
3.6.5	Communication Menu	EN-33
3.6.6	I/O Menu	EN-35
3.6.7	GMP Data Menu	EN-36
3.6.8	Lockout Menu	EN-37
3.6.9	Hardware Lockswitch	EN-38
4.	CARE AND MAINTENANCE	EN-39
4.1	Calibration	EN-39
4.1.1	Span Calibration	EN-39
4.1.2	Linearity Calibration	EN-40
4.1.3	Calibration Test	EN-41
4.1.4	Geographical Adjustment Factor	EN-42
4.1.5	GMP Calibration Printout	EN-44
4.2	Cleaning	EN-45
4.3	Troubleshooting	EN-45
4.4	Service information	EN-45
4.5	Battery Replacement	EN-46
4.5.1	Lithium Battery Replacement	EN-47
4.5.2	Rechargeable NIMH Battery Replacement	EN-47
5.	TECHNICAL DATA	EN-48
5.1	Drawings and Dimensions	EN-48
5.2	Technical Data	EN-50
5.3	Specifications	EN-50

TABLE OF CONTENTS FOR CKW-55 INDICATOR (Cont.)	Page
6. ACCESSORIES AND OPTIONS	EN-51
6.1 Available Options	EN-51
6.1.1 Relay Option	EN-51
6.1.2 RS485/422 Option	EN-51
6.1.3 Rechargeable Battery option	EN-51
APPENDIX A MAKING CONNECTIONS TO THE INDICATOR	EN-53
A.1 Load Cell Connections	EN-53
A.2 Jumper Positions	EN-54
A.3 Interface Connections	EN-54
A.3.1 Connecting RS232 Interface Cable	EN-54
A.3.2 Connecting External Input Device (Not supplied)	EN-54
APPENDIX B LEGAL FOR TRADE	EN-55
B.1 Setup Procedure	EN-55
B.2 Locking Metrological Parameters	EN-55
B.3 Verification	EN-56
B.4 Sealing	EN-56
APPENDIX C CKW INDICATOR MOUNTING	EN-59
APPENDIX D SERIAL COMMUNICATION	EN-61
D.1 Interface Commands	EN-61
APPENDIX E CAPACITY AND GRADUATION TABLE	EN-62
Limited Warranty	EN-63

List of Tables

Table Number	Title	Page
3-1	Parts and Controls	EN-8
3-2	Control Functions	EN-10
4-1	Geographical Adjustment Values	EN-43
4-2	Troubleshooting	EN-45
5-1	Dimensions	EN-48
6-1	Accessories and Options	EN-51
6-2	ASCII Number to Character Conversion	EN-52
D-1	Serial Interface Command Table	EN-61
E-1	Capacity and Graduation Table	EN-62

Figure Number	Title	Page
3-1	Indicator	EN-8
3-2	Scale	EN-8
3-3	Control Panel	EN-9
4-1	RTC Battery Removal/Installation	EN-46
5-1	CKW Series Scale	EN-48
5-2	CKW-55 Indicator Table Mount Position	EN-49
5-3	CKW-55 Indicator Wall Mount Position	EN-49
A-1	Cable Entry Identification	EN-53
A-2	Printed Circuit Board Connections	EN-53
A-3	Open and Shorted Jumpers	EN-54
B-1	Inside the Indicator Cover	EN-55
B-2	Internal Wire Seal	EN-57
B-3	Internal Sealing Label	EN-57
B-4	External Wire Seal	EN-58
B-5	External Sealing Label	EN-58
C-1	Mounting Bracket Dimensions	EN-60

1. INTRODUCTION

This manual contains installation, operation and maintenance instructions for the CKW-55 Indicator and CKW Series Scales. Please read this manual completely before installation and operation.

1.1 Description

The CKW Series is a dedicated static checkweighing product line with enhanced software and simplified user functionality. Its easy-to-clean, hygienic design and stainless steel construction make it specifically ideal for food processing and other wet-environment applications.

Behind this instrument stands Ohaus, a leading manufacturer of precision Indicators, Scales and Balances. An Aftermarket Department with trained instrument technicians is dedicated to providing the fastest service possible in the event this instrument requires servicing. Ohaus also has a Customer Service Department to answer any inquiries regarding applications and accessories.

1.2 Features

Major features include:

- Up to 20,000 maximum displayed resolution
- Stainless steel enclosure with NEMA 4X / IP66 protection
- Stainless steel 2-way table/wall mount bracket included, (Indicator only configuration)
- Supports up to four 350 ohm analog load cells
- High-contrast 0.8"/20 mm high, 6-digit, 7-segment LED weight display with adjustable brightness
- Configurable 3-color, 24-segment LED over-accept-under checkweigh indication with audible signal
- Numeric keypad and 7-function membrane switch operation with optional function lockouts
- One-button checkweigh target set point entries by weight range, variance, or % offset from target
- Flexible unit switching: kg, g, lb, oz, lb:oz, %
- Fast < 2-second display update speed
- 20-part library storage for: Product ID no., Minimum, Maximum, Target and Tare values
- GMP, Time/Date, Auto-Tare, Accumulation, Average and Standard Deviation
- Geographical adjustment function for remote calibration and certification in applicable areas
- Bi-directional RS232 interface
- User-configurable external input connection for remote tare, zero, print and other operations
- Universal switching power supply: nominal 100-240 V ac, 50-60 Hz
- Scale models include a tubular column: 304 stainless steel, 11.8" / 300 mm fixed height with indicator and base mounting brackets

Optional features include:

- RS485/422 Serial Communication
- AC/DC Relay output
- Internal rechargeable nickel metal hydride (NiMH) battery

1.3 Safety Precautions



For safe and dependable operation of this equipment, please comply with the following safety precautions:

- Verify that the input voltage range printed on the data label matches the local AC power to be used.
- Make sure that the power cord does not pose a potential obstacle or tripping hazard.
- Use only approved accessories and peripherals.
- Operate the equipment only under ambient conditions specified in these instructions.
- Disconnect the equipment from the power supply when cleaning equipment .
- Do not operate the equipment in hazardous or unstable environments.
- Do not immerse the equipment in water or other liquids.
- Do not drop heavy loads on the platform.
- Service should only be performed by authorized personnel.
- This equipment is supplied with a grounded power cable. Use only with a compatible grounded power outlet.

1.3.1 Relay Option Safety Precautions

This equipment may have an optional AC or DC Relay Option board installed. This option allows external device control to be coordinated to the Indicator's bar graph settings.



CAUTION: ELECTRICAL SHOCK HAZARD. REMOVE ALL POWER CONNECTIONS TO THE INDICATOR BEFORE SERVICING OR MAKING INTERNAL CONNECTIONS. THE HOUSING SHOULD ONLY BE OPENED BY AUTHORIZED AND QUALIFIED PERSONNEL, SUCH AS AN ELECTRICAL TECHNICIAN.

Before making connections to the Relay terminals, remove power from the system. If the system contains an optional rechargeable battery system, be sure that the **ON/ZERO Off** button is used to fully turn off the system after removing the AC power plug.

More detailed installation instructions are included with the Relay Option Kit when purchased.

2. INSTALLATION

2.1 Unpacking and Checking

Unpack and verify that the following components have been included:

- CKW-55 Indicator
- Instruction Manual
- 2-way Mounting Bracket (with stand-alone indicator)
- Weights and Measures Kit
- Warranty Card
- Complete Scale models also include:
 - o Column
 - o Base Assembly
 - o CKW Base Instruction Manual

Retain all of the original packaging materials in the event the unit has to be transported or stored.

2.2 Selecting the Location

This equipment should be used in an environment free from vibration, temperature extremes or highly corrosive conditions. These factors may affect normal operation of the unit.

Scale bases used with the CKW-55 Indicator must be located on a stable level surface and kept away from vibrating sources such as large machinery or appliances.

Adjust the leveling feet so that the bubble is centered in the circle of the level indicator located in the rear of the scale.

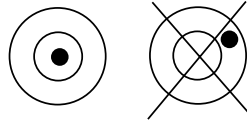

Note: Ensure that the scale is level each time its location is changed.

2.3 Connecting Power

2.3.1 AC Power

Plug the AC power cord into a properly grounded power outlet. The CKW Indicator utilizes a universal switching power supply that operates from 100 to 240 VAC / 50 to 60 Hz.

2.3.2 Battery Power (Optional equipment)

The scale can be operated on the internal rechargeable battery when AC power is not available. The scale will automatically switch to battery operation if there is a power failure or the power cord is removed. A fully charged battery can operate the scale for over 10 hours independent of the AC power line. When the battery requires charging, Lo Bat is displayed during operation. The scale will automatically turn off when the battery is fully discharged.

With AC power applied to the scale, the bar graph may start flashing a yellow bar segment indicating charging is in progress. As the battery is charged, the segments on the bar graph continue to advance until the first green segment is reached. A flashing green segment indicates that the battery is fully charged.



Before using the scale on battery power for the first time, the internal rechargeable battery requires charging for up to 14 hours. The scale can be operated on AC power during the charging process. The battery is protected against over charging and the scale can remain connected to the AC power line.

 <h2 style="margin: 0;">CAUTION</h2>
<p>BATTERY IS TO BE REPLACED ONLY BY AUTHORIZED SERVICE PERSONNEL.</p> <p>RISK OF EXPLOSION CAN OCCUR IF REPLACED WITH THE WRONG TYPE OR CONNECTED IMPROPERLY.</p>



CAUTION: Do not dispose of used batteries in normal trash. Follow the proper disposal or recycling requirements in accordance with local laws and regulations.

2.4 Initial Calibration

Scales are factory calibrated prior to shipping. If calibration is required, refer to section 4.1.

3 OPERATION

3.1 Overview of Parts and Controls

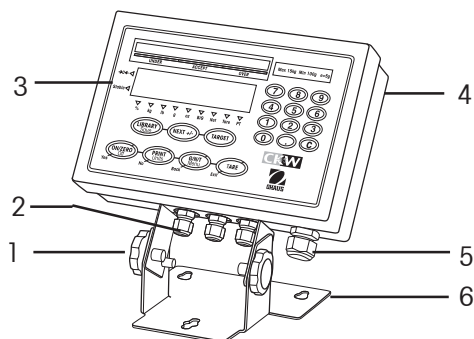

Figure 3-1. Indicator.

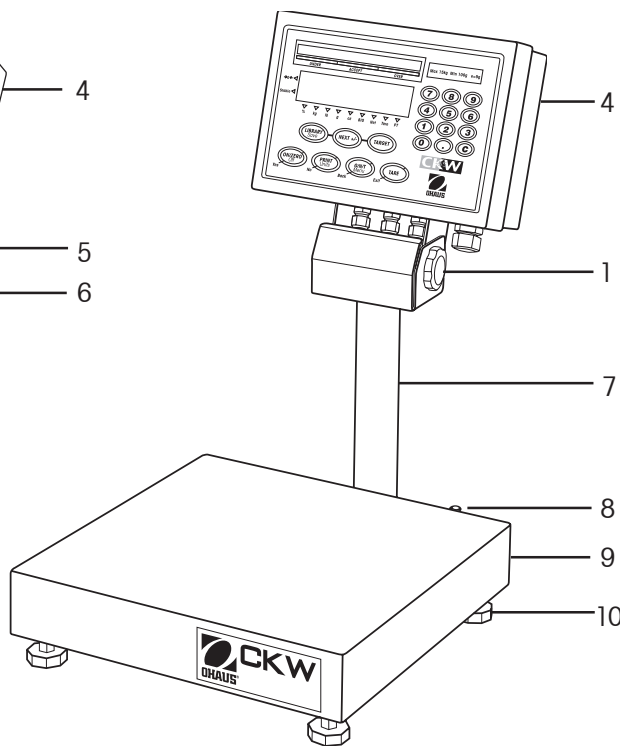

Figure 3-2. Scale.

TABLE 3-1. PARTS AND CONTROLS.

Item	Description
1	Adjusting Knob
2	I/O Ports
3	Control Panel
4	Indicator Case
5	AC Power Input
6	Table/Wall Bracket
7	Column
8	Level Indicator
9	Weighing Platform
10	Adjusting Feet

3.1 Overview of Parts and Controls (Cont.)

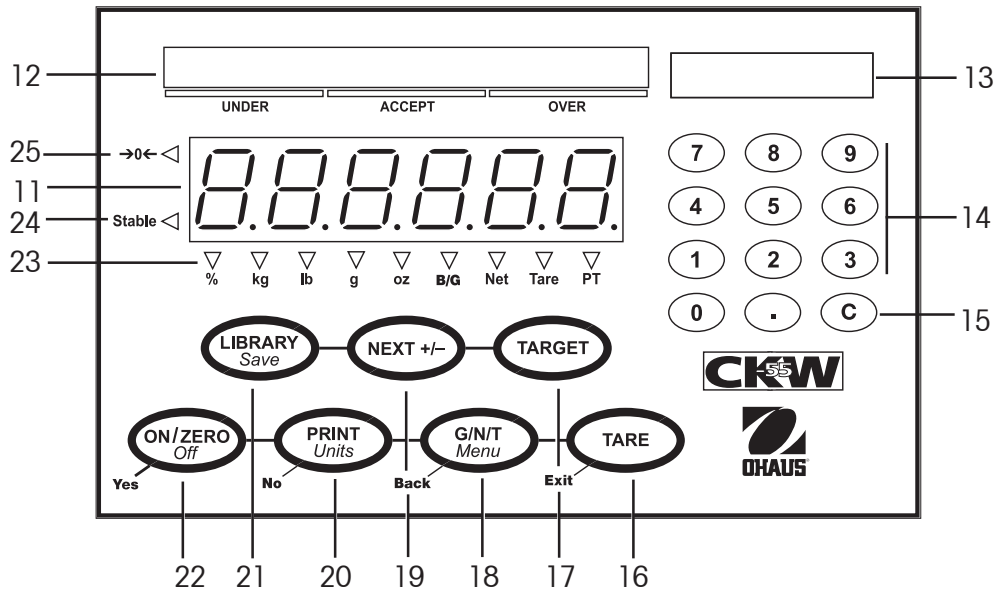









Figure 3-3. Control Panel.

TABLE 3-1. PARTS AND CONTROLS (Cont.).

Item	Description
11	Weight Display
12	Checkweigh Bar Graph
13	Capacity Label Window
14	Numeric Keypad
15	C clear button
16-22	Control Buttons See Table 3-2
23	Weighing Units, Brutto/Gross, Net, Tare, Preset Tare Indicators
24	Stable Indicator
25	Center of Zero Indicator

3.2 Control Functions

TABLE 3-2. CONTROL FUNCTIONS.

	 Primary Function Secondary Function Navigation Function—Yes	 No	 Back	 Exit			
	ON/ZERO	PRINT	G/N/T	TARE	LIBRARY	NEXT +/-	TARGET
Primary Function (Short Press)	<ul style="list-style-type: none"> • Turns the indicator on. • If indicator is on, sets zero. 	<ul style="list-style-type: none"> • Sends current display value to the serial interface. 	<ul style="list-style-type: none"> • Displays gross, net and tare values. 	<ul style="list-style-type: none"> • Performs tare operation. • Saves pre-set tare after numeric entry. 	<ul style="list-style-type: none"> • With Library mode on, initiates library view/entry/edit sequence. 	<ul style="list-style-type: none"> • Adds displayed weight into accumulation memory. • Toggles numeric data entry between + and -. 	<ul style="list-style-type: none"> • With checkweigh mode on, initiates target view/entry/edit sequence. • Saves and steps through target data.
Secondary Function (Long Press)	<ul style="list-style-type: none"> • Turns indicator off. 	<ul style="list-style-type: none"> • Changes the weighing unit. 	<ul style="list-style-type: none"> • Enters menu mode. 		<ul style="list-style-type: none"> • Save With Library mode on, saves library data and loads to active weighing mode. 	<ul style="list-style-type: none"> • Displays statistical information of accumulated weighing memory. 	
Navigation Function (Menu Mode)	<ul style="list-style-type: none"> • Enters the current menu shown on the display. • Accepts the current setting on the display. 	<ul style="list-style-type: none"> • Advances to the next menu. • Rejects the current setting on the display and advances to the next available setting. 	<ul style="list-style-type: none"> • Moves backwards through upper and medium level menus. • Backs out of lower level menus and settings. 	<ul style="list-style-type: none"> • Exits the present mode and returns directly to the weighing mode. 			

3.3 Menu

3.3.1 Menu Structure

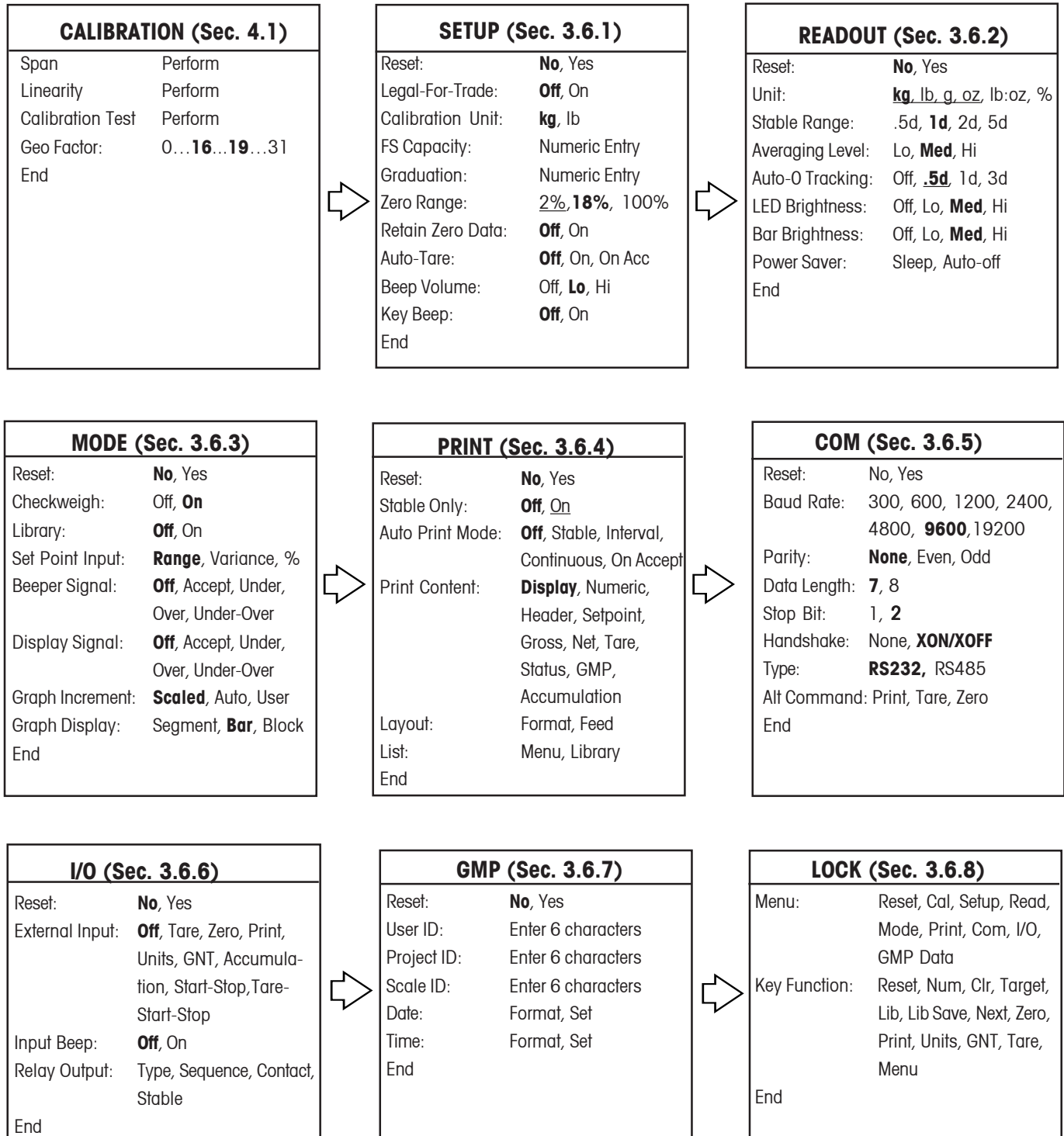

- NOTES:**
- Bolded** items indicate factory default settings.
 - The unit selected for "Calibration Unit" will become the default "On" unit in the event that all other units are set to "Off".
 - When the Legal for Trade setting is changed to "On", the following items are affected:
 - Span and Linearity calibration are unavailable, Geo factor is viewable but not alterable, Cal Test will operate.
 - Underlined menu items become forced as default.
 - Some menu items may only become available when certain optional accessories are installed.
 - Using the Reset function in the "SETUP" menu will not change the values entered for FS Capacity or Graduation.

3.3.2 Menu Navigation

TO ENTER THE MENU MODE

Press and hold the **Menu** button until MENU appears on the display. The first upper level menu CAL appears on the display.

Summary of button navigation functions in menu mode:

- Yes** - Allows entry into the displayed menu.
 - Accepts the displayed setting and advances to the next menu item.
- No** - Skips by the displayed menu.
 - Rejects the displayed setting or menu item and advances to the next available item.
- Back** - Moves backwards through the upper and middle level menus.
 - Backs out of a list of selectable items to the previous middle level menu.
- Exit** - Exits from menu directly to the active weighing mode.

3.4 Turning Indicator On/Off

3.4.1 Turning On

With the scale off, press the **ON/ZERO Off** button. The Indicator performs a display-test, momentarily indicating model, option and status information, and then goes into the active weighing mode.

3.4.2 Turning Off

To turn the Indicator off, press and hold the **ON/ZERO Off** button until OFF is displayed.

3.4.3 Stabilization

Before initially using the indicator, allow time for it to adjust to its new environment. The recommended warm-up period is five (5) minutes after the scale has stabilized to room temperature.

3.5 Application Modes

Before using the CKW-55 Indicator, make sure it has been properly set up and calibrated (refer to Sections 3.3.2 Menu Navigation and Section 3.6.1 Setup Menu).

If the unit is received as a scale, it has been factory calibrated and can be operated at this point using the factory default settings. To ensure optimal accuracy, Ohaus recommends that the Scale be re-calibrated before use (refer to Section 4.1 for Calibration and Appendix B Legal for Trade Sealing if required).

3.5.1 Weighing

Zero Operation

Press the **ON/ZERO Off** button to zero the weight display. The scale must be stable to accept zero operation.



Basic Weighing

Place the item to be weighed on the Scale platform. The illustration indicates a sample of 1.5 kg, Gross weight.

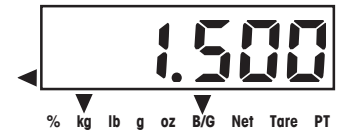

Manual Tare

When weighing an item that must be held in a container, taring stores the container weight into the Indicator's memory. Place the empty container to be tared on the scale platform (example 0.5 kg).



Press the **TARE** button. The container weight is tared. The display will show 0 kg, Net weight.



To clear the Tare value, empty the scale platform (the display will show the tare weight as a negative value). Press the **TARE** button. Display will show 0 kg, Gross weight.

Pre-Set Tare

A Pre-set Tare (PT) is a known tare value entered through the numeric keypad. The PT value will supersede any other Tare or PT value in memory. (When using Pre-Set Tare, make sure that Auto-Tare function is set off in the Setup menu.)

To initiate a Pre-set Tare, enter a numeric value using the keypad (example 1.000 kg), then press the **TARE** button.



Display will show the Pre-set Tare as a negative value, with the PT indicator on.

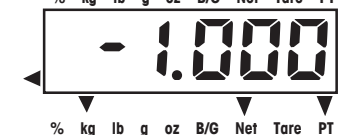

- Notes:**
1. If the **TARE** button is not pressed 5 seconds from the last numeric entry, the display returns to the previous mode without a tare being stored.
 2. To clear a Pre-set Tare value, empty the pan then press the **TARE** button. The display will return to 0 kg, Gross weight.

Auto-Tare

Auto-Tare automatically tares the initial weight (such as a container) placed on the empty platform, without having to press the **TARE** button. The tare value is cleared automatically when the weight on the pan is fully removed.

In Auto-Tare mode, the Tare indicator blinks when waiting for a Tare item to be placed on the empty scale platform (with LFT On, there is no flashing Tare indicator).

When the On Accept setting is selected, weight values that are within the accept range will be tared automatically.

Note: Auto-Tare supersedes any pre-set (PT) value in memory.

Displaying Gross, Net, Tare

When a tare has been entered, pressing the **G/N/T Menu** button successively displays the Tare, the Gross, and the Net weights. After a few seconds the scale automatically reverts to displaying the NET weight.

Changing Units of Measure

Press and hold the **PRINT Units** button until the desired measuring unit appears. Only measuring units enabled in the Readout-Unit Menu will be displayed (refer to Section 3.6.2).

Printing Data

Printing the displayed data to a printer or sending the data to a computer requires that the communication parameters in the Print and Communication Menu are set (refer to Sections 3.6.4 and 3.6.5).

Press the **PRINT Units** button to send the displayed data to the RS232 port (the Auto-Print Mode in Section 3.6.4 function must be Off).

Note: If the **PRINT Units** button is pressed too long, the display advances to another measuring unit without sending the print data.

Accumulation Operation

The Accumulation function is always on and allows basic statistical information to be collected from multiple weighings. Accumulated data collected includes total count (or number of samples), total sample weight, average sample weight, and a standard deviation of sample weight. The information continues to accumulate and is retained until cleared or the scale is turned off.

To add a weight value to the Accumulation memory, place the item on the platform, then short press the **NEXT +/-** button. M-ADD is momentarily flashed on the display to indicate that the value is added into memory. Repeat this step for each additional item.

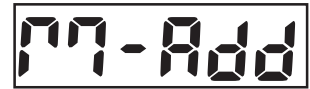

To view the Accumulation data, long press the **NEXT +/-** button. Accumulation data is displayed momentarily in the following sequence:

Display parameter COUNT, then the total number of weighed samples (example 150).



Display parameter TOTAL, then the total accumulated weight value (example 1504.05 kg).



% kg lb g oz B/G Net Tare PT

Display parameter AVG, then the calculated average of the accumulated values (example 10.03 kg).



% kg lb g oz B/G Net Tare PT

Display parameter S-DEV (standard deviation), then the calculated standard deviation (example 4.502 kg).



% kg lb g oz B/G Net Tare PT

Display END, then the display returns to the active weighing mode.



To clear the Accumulation memory, press the **C** button during the display sequence. At the end of the display sequence, CLEAR is displayed and returns to active weighing mode.



- Notes:**
1. If a value exceeds the size of the 6 digit display, the number will first be displayed in reduced decimal places, after this, the g and lb:oz units may be changed to kg and lb units. If the value still exceeds the display digits, Err will be displayed. The correct value with the original weighing unit will always be printed when the Accumulation data is printed.
 2. I/O- External Input setting should NOT be set to: S-S or T-S-S (refer to Section 3.6.6), since this menu setting also controls the functionality of the **NEXT +/-** button. The accumulate function is not available if either of these I/O selections are made.

3.5.2 Checkweighing

The CKW Series features multiple user-configurable checkweighing functions that permit weighing items against preset minimum-maximum and target parameters.

- Notes:**
1. Checkweighing and target entry operations are enabled only when Checkweigh is turned on in the Mode Menu (refer to Section 3.6.3, Mode Menu). When enabled from the menu, Checkweigh mode is automatically active upon exiting from the Mode Menu.
 2. The weight of the item being checked is net of any Tare or Pre-set Tare value.

Bar Graph, Beeper and Weight Display Indication

The CKW-55 Indicator features a 24-segment, 3-color Bar Graph, complemented by an audible Beeper and Weight Display visual alert (refer to Sections 3.6.1 Setup Menu and 3.6.3 Mode Menu). These checkweigh indication features are easily configurable and can be turned on or off to suit most user preferences.

Bar Graph segments illuminate according to the following conditions:

- Under (yellow) = weight is below preset minimum value.
- Accept (green) = weight is equal or within preset target range.
- Over (red) = weight exceeds preset maximum value.

NOTE: The checkweigh **TARGET** button and menu settings can be locked to resist tampering of checkweigh parameters (refer to Sections 3.6.3 Mode Menu and 3.6.8 Lock Menu).

Summary of Checkweigh Key Functions

Use the following buttons to establish checkweigh set point values (Checkweigh Mode is on).

TARGET Checkweigh Start, Accept and Advance button.

1. Initiates the Target setting sequence and
2. Accepts the displayed values and advances to the next sequence.

C In numeric entry sequence, short press clears one digit at a time, long press erases the display (shows - - - - -). Re-enter a new value.

NEXT +/- Toggles the displayed value being entered between negative and positive.

Programming Accept Range by Numeric Key Entry

In the Mode menu, set Checkweigh to On and Set Point Input to Range (refer to Section 3.6.3).

NOTE: The under and over set points are included in the Accept range.



Press the **TARGET** button to initiate check weigh entry sequence. UNDER flashes momentarily to indicate the first parameter to be entered. The last Yellow and the first Green Bar Graph segments are lit during entry.

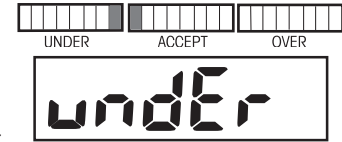

The display flashes the last Minimum range value entered. Use the numeric keypad to enter a new Minimum range value.

Note: -NO- is displayed if the entered value is out of range or is not compatible with the graduation settings, (refer to Section 3.6.1).

Press **TARGET** to accept the entry. The display will freeze momentarily to confirm the entry.

OVER flashes momentarily to indicate the parameter to be entered next. The last Green and the first Red Bar graph segments are lit during entry.

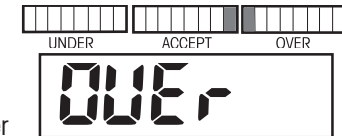

The display flashes the last maximum range value entered. Use the numeric keypad to enter a new Maximum range value or press **C** to clear. .

Press **TARGET** to accept the entry. The display will freeze momentarily to confirm the entry.

END appears momentarily to confirm end of checkweigh entry sequence. The Indicator returns to active checkweighing mode.



- NOTES:**
1. Values entered can be from 1d to Full Scale capacity.
 2. Minimum range value cannot be greater than maximum range value unless both values are negative.
 3. For entry in the lb:oz units, the first decimal point entered is used as the lb oz separator, (eg. an entry of 2.08.3 = 2 lb 8.3 oz. At least one digit must be entered for the lb location, eg., an entry of 0.15.9 = 0 lb 15.9 oz.

Programming Target, Minimum and Maximum Variance Values

In the Mode menu, set Checkweigh to On and Set Point Input to Variance (refer to Section 3.6.3). Under and over values are entered as the variance from the target value.

Press the **TARGET** button to initiate checkweigh entry sequence. TARGET flashes momentarily to indicate the first parameter to be entered. The two center Green bar Graph segments are lit during entry.

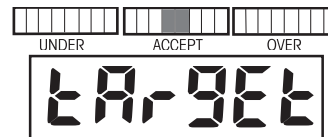

The display flashes the last Accept Target value entered. If a different Accept value is desired, enter the new value via the numeric keypad (example 4 kg).

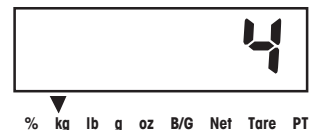

Press the **TARGET** button to accept the entry. The display will freeze momentarily to confirm the entry.



VAR UN flashes momentarily to indicate the parameter to be entered next (Variance-Under). The last Yellow and the first Green Bar Graph segments are lit during entry.

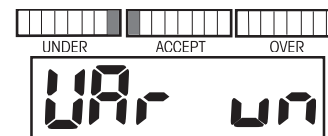

The display flashes the last Minimum Variance value entered. If a different Minimum Variance value is desired, enter the new value via the numeric keypad (example 1 kg).

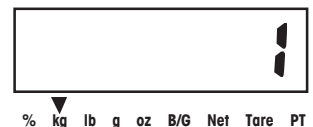

Note: Variance values are absolute, no negative value allowed.

Press **TARGET** to accept the entry. The calculated value 3.000 (4 kg – 1 kg) will freeze momentarily to confirm the entry.



VAR OV flashes momentarily to indicate the parameter to be entered next (Variance-Over). The last Green and the first Red Bar Graph segments are lit during entry.

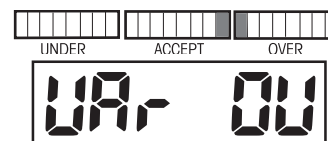

The display flashes the last Maximum Variance value entered.

If a different Maximum Variance value is desired, enter the new value via the numeric keypad (example 1.5 kg).

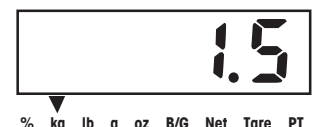

Press **TARGET** to accept the entry. The calculated value 5.500 (4 kg + 1.5 kg) will freeze momentarily to confirm the entry.

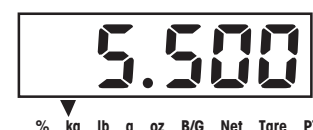

END appears momentarily to confirm end of checkweigh entry sequence. Indicator returns to active checkweighing mode.

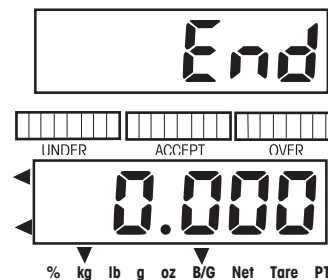

Programming Target, and Minimum and Maximum % Variance

In the Mode menu, set Checkweigh to On and Set Point Input to Percent (refer to Section 3.6.3).

Press the **TARGET** button to initiate checkweigh entry sequence. TARGET flashes momentarily to indicate the first parameter to be entered. The two center green Bar Graph segments are lit during entry.

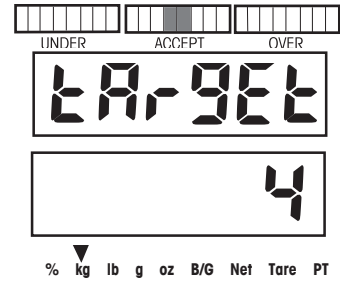

The display flashes the last Accept Target value entered. If a different Accept value is desired, enter the new value via the numeric keypad (example 4 kg).

Press **TARGET** to accept the entry. 4.000 will freeze momentarily to confirm the entry.



VAR UN flashes momentarily to indicate the parameter to be entered next (Variance-Under). The last Yellow and the first green segments are lit during entry.

The display flashes the last Minimum % variance entered. If a different Minimum % variance is desired, enter the new value via the numeric keypad (example 25% of the Accept Target value 4 kg to reach a desired Minimum value of 3 kg).

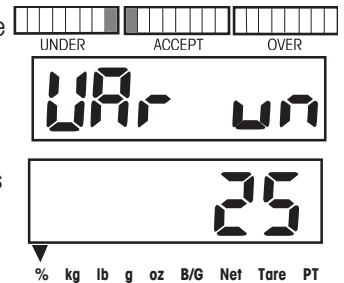

Note: Variance values are absolute, no negative value allowed.

Press **TARGET** to accept the entry. The calculated value 3.000 (4 kg – 25% or 1 kg) will freeze momentarily to confirm the entry.

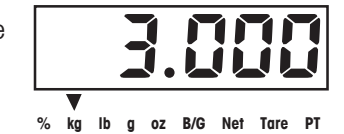

VAR OV flashes momentarily to indicate the parameter to be entered next (Variance-Over). The last Green and the first red bar graph segments are lit during entry.

The display flashes the last maximum variance value entered.

If a different maximum % variance is desired, enter the new value via the numeric keypad (example 37.5% of the Accept Target value 4 kg to reach a desired maximum value of 5.5 kg).

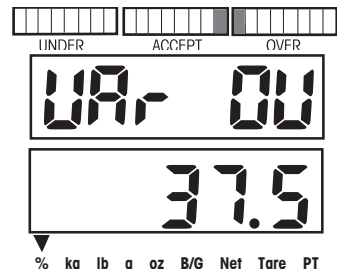

Press **TARGET** to accept the entry. The calculated value 5.500 (4 kg + 37.5 % or 1.5 kg) will freeze momentarily to confirm the entry.

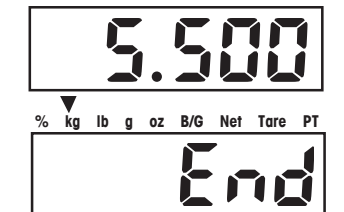

END appears momentarily to confirm end of checkweigh entry sequence. Indicator returns to active checkweighing mode.

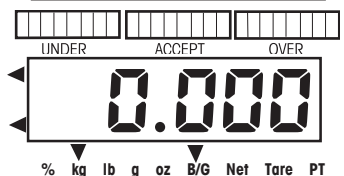

Normal Checkweighing Operation

Normal checkweighing is used to determine when the weighed sample is within the target range. In this example, Target range settings are Under 3 kg and Over 5.5 kg.

If a container is used, tare it first.

Place the item to be weighed on the scale platform. The illustration indicates a sample weight of 4.25 kg. The bar graph display indicates weight is within the Accept range.

Negative Checkweighing Operation

Negative checkweighing is used to determine when the removed material is within the Target range. Press the **TARGET** button and set the Under and Over values as a negative value. This is done by entering the number first, then pressing the +/- button. In this example, Target range settings are Under -3 kg and Over -4.5 kg.

Place the item to be weighed on the scale platform. The illustration indicates a sample of 5.25 kg, Gross weight.

Tare the weight of the item.

Remove a portion of the item. The illustration indicates the removal of a 3.5 kg portion. The bar graph display indicates weight is within the Accept range.

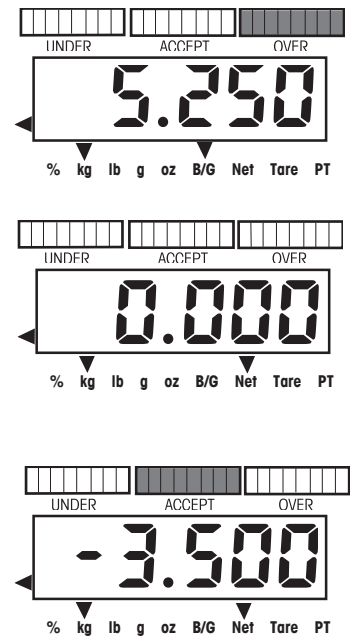
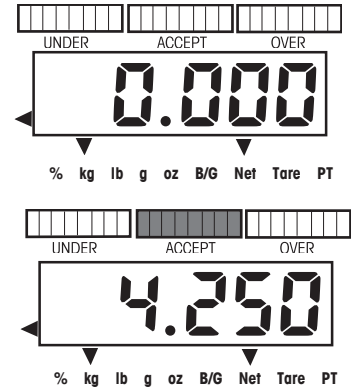

Zero Checkweighing Operation

Zero Checkweighing is used when comparing subsequent samples to an initial reference sample. Press the **TARGET** button to set target to zero, then set the Variance Under and Over values. In this example, Under and Over values are 0.050 kg.

Note: Any number entered for the Under value will automatically be a negative number.

Place the item representing the reference weight on the scale platform. The illustration indicates 1 kg.

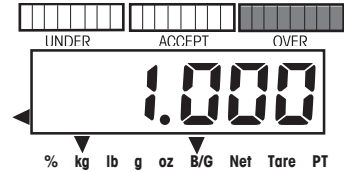

Tare the reference sample.

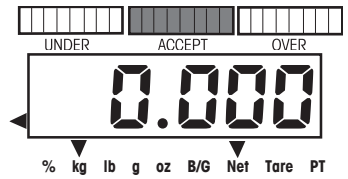

Remove the reference sample from the platform. In this example, any weight that is 0.050 kg or more below 1 kg will display UNDER.

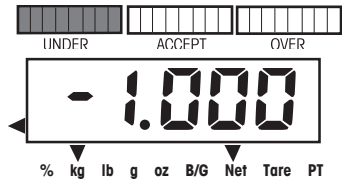

Place the item to be compared on the scale platform. The illustration indicates that the sample is 0.020 kg above the 1 kg reference weight and is within the accept range.

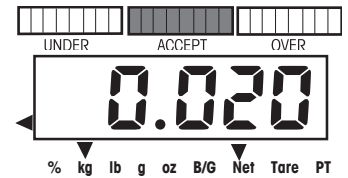

3.5.3 Library Operation

The CKW-55 Indicator allows the storage of checkweighing data in 20 Library locations, designated ID 01 to ID 20. Each Library location includes: a Part Number or name, Pre-set Tare, Maximum, Minimum, and Target value. Data entered into the libraries can be recalled for use, edited or deleted.

The **LIBRARY Save** button can be locked to prevent unauthorized changes to the data (refer to Section 3.6.8 Lockout Menu).

Summary of Library Key Functions

Use the following buttons to establish checkweigh set point values (Checkweigh Mode and Library is on).

LIBRARY Save Short Press

1. Initiates the Library sequence, and
2. Accepts the displayed values and advances to the next sequence.
Long Press during part number display or while END is displayed loads the library data, and exits to active weigh mode.

NEXT +/-

1. During a Library ID display, short press advances to the next higher Library ID.
2. Long press will begin scrolling through Lib ID's more quickly.
3. During Part Number entry, converts a 3 digit ASCII code to an alpha-numeric character.
4. During numeric value entry sequence, short press toggles the displayed value between negative and positive.

C

1. Short press in numeric entry sequence, clears one digit at a time. A long Press during data entry erases all digits.
2. While END is displayed, a long press will erase the data in the selected library.

Exit

Exits any Library function.

Entering and Editing Library Data

In the Mode menu, Library should be On. Library data is viewed in the Set Point Input setting as it was entered. In this example, Set Point Input setting is Variance.

Note: In Library entry mode, **LIBRARY Save** is used to confirm and advance to the next setting instead of **TARGET** button. Press the **LIBRARY Save** button to display the last active Library ID.

A digital display showing the text 'L 16 01' in a seven-segment font. The 'L' is on the left, '16' is in the middle, and '01' is on the right.

To choose another Library ID location, press the **NEXT +/-** button. The next Library ID location flashes, then the corresponding Part Number.

A digital display showing the text 'L 16-02' in a seven-segment font. The 'L' is on the left, '16' is in the middle, and '-02' is on the right.

Display shows a flashing - - - - - to indicate that there is no existing Part Number specified for this Library ID location. For improved identification, an identifying part number or product ID may be entered.

Enter the desired Part Number (up to 6 digits + 6 decimal points) (example 30123.0) using the numeric keys.

A digital display showing the text '30 123.0' in a seven-segment font. '30' is on the left, '123.0' is on the right.

Entering and Editing Library Data (Cont.)

or

To enter letters instead of numbers, use the ASCII entry format: Enter a 3 digit ASCII code shown in Table 6-2, then press **NEXT+/-** button. The 3 digits convert to an equivalent single ASCII character, non-displayable ASCII codes produce `_'". (Example: HAM-6 = 072, **NEXT +/-**, 065, **NEXT +/-**, 077, **NEXT +/-**, 109, **NEXT +/-**, 045, **NEXT +/-**, 6.)

Note: two entries are required to make the letter M or W. (Use upper case followed by the lower case ASCII code value).

Press **LIBRARY Save** and advance to the next parameter: Pre-set Tare. P-TARE momentarily flashes.

Display flashes 0.000 or the last value entered. Use the numeric keys to enter the desired Pre-set Tare value (example 0.500 kg).

In the following example, Variance has been selected as the Set Point Input in the Mode menu. Press **LIBRARY Save** to save the current entry and advance to the next parameter: TARGET momentarily flashes.

- Notes:**
1. - - - - - is displayed if no previous data was specified for the respective parameters.
 2. Use the **C** button to clear previous data.

Enter the desired value (example 4 kg) using the numeric keys.

Press **LIBRARY Save** to save the current entry and advance to the next parameter: VAR UN (Variance-Under).

Note: Variance values are absolute, no negative value allowed.

Enter the desired Minimum tolerance value (example 1 kg) using the numeric keys.

Press **LIBRARY Save** to accept the entry. The calculated value 3.000 (4 kg – 1 kg) will freeze momentarily to confirm the entry.

Advance to the next parameter: VAR OV (Variance-Over). VAR OV flashes momentarily. The last Green Bar Graph and the first Red segment are displayed during entry.

Enter the desired Maximum tolerance value (example 1.5 kg) using the numeric keys.

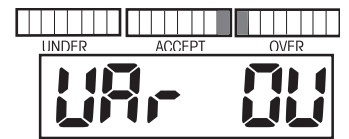
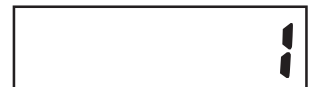
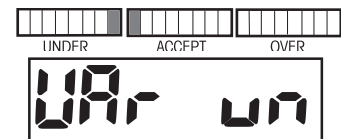
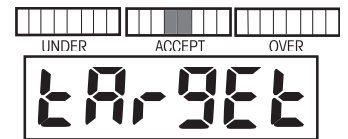
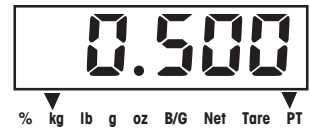

Entering and Editing Library Data (Cont.)

Press **LIBRARY Save** to accept the entry. The calculated value 5.500 (4 kg + 1.5 kg) will freeze momentarily to confirm the entry.

Display -END- indicates end of Library entry sequence.

To review data entries before saving, short press **LIBRARY Save** to cycle through entries.

Long press **LIBRARY Save** to save and exit to active weighing mode. While exiting the weighing mode, the Library ID **SAVED** and **READY** is momentarily displayed.

OR

To cancel the entries, short press the **C** button while **END** is displayed. While exiting to the weighing mode, **CANCEL** is momentarily displayed. Data entries are not saved and the original data are retained.

Loading an Existing Library to the Active Checkweigh Mode

Press the **LIBRARY Save** button. The last Library ID momentarily flashes followed by the part number or name assigned.

To advance to another Library ID, repeatedly press the **NEXT +/-** button until the desired Library is reached.

To load the selected Library ID, long press **LIBRARY Save**. While exiting to the weighing mode, the Library ID and **READY** are displayed.

Note: If no button is pressed within 30 seconds, no changes are retained and the display returns to the weighing mode.

Reviewing Library Data

To review Library data, the Library must be set On.

If the library is Off, pressing the **LIBRARY Save** button will display the message -NO-, and returns to the active weighing mode.

Press **LIBRARY Save** button, the last active Library location and Part Number will be displayed. Press the **NEXT +/-** button to advance to another Library, or press **LIBRARY Save** button to review the current Library data. Continue to press **LIBRARY Save** button until all data has been reviewed. When END is displayed, press the **TARE Exit** button to cancel and exit, or press **LIBRARY Save** button then **NEXT +/-** button to continue reviewing additional Libraries.

Erasing Library Data

Access the desired Library to be removed using the **LIBRARY Save** button and **NEXT +/-** button. Repeatedly press the **LIBRARY Save** button until END is displayed. Long press the **C** button, the Library ID is displayed, then CLEAR is displayed. The contents of the selected Library is erased.

3.6 Scale Settings

This section describes the settings available in each menu.

3.6.1 Setup Menu

Access this Menu to configure metrological parameters.

Reset

This menu item is used to reset the Setup menu to the factory defaults.

Note: Capacity and graduation settings are not reset.

Selections are: **No**, Yes

Legal for trade

This menu item is used to enable or disable Legal for trade compliant operation.

Selections are: **OFF**, On.

Note: Certain menu items are restricted as shown in Section 3.3.1.

Calibration Unit

This menu item is used to define the unit of measure for calibration.

Selections are: **kg**, lb.

Full Scale Capacity

This menu item is used to define the capacity setting of the scale.

The display flashes the last Full Scale Capacity value entered.

If a different Full Scale Capacity value is desired, enter the new value via the numeric keypad. Values entered are whole numbers from 1 to 100,000 (refer to Appendix E for typical values).

Note: Changes will require a re-calibration for correct operation.

Graduation

This menu item is used to define the scale readability. The display flashes the last Graduation value entered. If a different Graduation value is desired, enter the new value via the numeric keypad.

Notes:

- 1.Values entered must be submultiples of 1, 2 or 5, and between 0.0001 to 50, (refer to Appendix E for typical values).
- 2.Full Scale Capacity and Graduation combinations may not exceed 20,000 divisions for CKW-55 Indicators or 6000 to 7500 divisions for CKW Scales. Invalid entries will result in a display -NO- and will not be saved.
- 3.With LFT set to ON, Full Scale Capacity and Graduation combinations may not exceed 10,000 for CKW-55 Indicators, or 3,000 for CKW Scales
- 4.When Full Scale Capacity and graduation combinations exceed the resolution limits, the Graduation value will be adjusted automatically.

Zero Range

This menu item is used to define the percentage of full capacity load that may be cleared by pressing the **ON/ZERO Off** button. Selections are: 2%, **18%** and 100%.

Note: With LFT On, Zero Range defaults to 2%.

Retain Zero Data

This menu item is used to enable or disable Retain Zero Data function. When set On, indicator stores the current zero point and restores it on power-up. Selections are: **OFF**, On.

Auto-Tare

Selections are:

OFF = Auto-Tare is Off.

ON = Auto-tare is On.

ON ACC= Auto-Tare On accept is enabled. When On Acc is selected, a delay value may be entered using the numeric keypad.

(0.5 - 5)= The value entered must be from 0.5 to 5 seconds.

Beeper Volume

This menu item is used to define the beeper volume. Selections are: HI, **LO** and OFF.

Beeper Key

This menu item is used to enable or disable the beeper. Selections are: **OFF**, ON.

End

Represents the end of the menu.

3.6.2 Readout menu

The Readout menu is used to configure display parameters and adopt the scale to environmental conditions.

Reset

This menu item is used to reset the Readout menu to factory defaults. Selections are: **No**, Yes.

Units

This menu item is used to define which units will be enabled for use. Selections are: **kg**, lb, g, oz, lb:oz, percent. In the event that all units are set to Off, the unit selected for calibration will be forced ON. After pressing the **Yes** button, each unit may be set to OFF or ON.

Note: Percent unit is only available with a checkweigh target value. (See Section 3.6.3 Mode-Set Point Input and Section 3.5.2 Checkweigh Operation). The displayed value is the percent relative to the target weight value (example, if a target value is 100 kg, a 100 kg weight is displayed as 100%, 75 kg is displayed as 75%, 150 kg is displayed as 150%).

Stable Range

This menu item is used to specify a tolerance limit to indicate a Stable condition (Stable indicator turns on). Selections are: 0.5, **1**, 2, 5 (scale divisions).

Averaging Level

This menu item is used to specify how much filtering is used to compensate for vibration or excessive air currents. Selections are: Lo, **Med**, Hi.

Auto-Zero Tracking

This menu item is used to define the Auto-Zero Tracking threshold. AZT minimizes the effects of temperature changes and small disturbances on the zero reading. The scale maintains the zero display until the threshold is exceeded. Selections are: OFF, **0.5**, 1, 3 (scale divisions).

Weight Display Brightness Level

This menu item is used to define the brightness of the weight display. Selections are: OFF (display blank), Lo, **Med**, Hi.

Bar Graph Brightness Level

This menu item is used to define the brightness of the Bar Graph display. Selections are: OFF, Lo, **Med**, Hi.

Power Saver

This menu item is used to enable power saving function. Selections are:

SLEEP

Specifies the number of minutes that the display will remain on in the absence of scale activity. The display flashes the last Sleep value entered. Values between 0 to 99 are entered via the numeric keypad. A value of 0 is equal to Sleep mode OFF.

Note: With LFT turned On, the scale must be at center of zero for sleep mode to initiate.

AUTO-OFF

Specifies the number of minutes that the Indicator will remain on in the absence of scale activity. The display flashes the last value entered. Values between 0 to 99 are entered via the numeric keypad. A value of 0 is equal to Auto-Off Timer OFF.

END

Represents the end of the menu.

3.6.3 Mode Menu

The Mode menu is used to configure parameters of the available application modes.

Reset

This menu item is used to reset the Mode menu to factory defaults. Selections are: **No**, Yes.

Checkweigh Mode

This menu item is used to enable or disable the Checkweigh mode. Selections are: OFF, **On**.

Library Mode

This menu item is used to enable or disable the Library mode.

Selections are: **OFF**, On.

Set Point Input

This menu item is used to define checkweigh set point formats. (refer to Section 3.5.2).

Selections are:

Range (RNG) = Acceptance range between a Minimum (under) and Maximum (over) value.

Variance (VAR) = Input a Target value and the Minimum and Maximum weight variance from the Target.

Percent (PCT) = Input a Target value and the Minimum and Maximum % variance from the Target.

Note: Changing the set-point input settings clears existing set-point entries.

Beeper Signal

This menu item is used to define when beeper sounds an (audible alert) during checkweighing.

Selections are:

OFF = Beeper does not sound.

Accept = Beeper sounds when the weighed value is within the Accept range (corresponding to green LED bar graph area).

Under = Beeper sounds when the weighed value is below the minimum acceptable range (corresponding to yellow LED bar graph area)*.

Over = Beeper sounds when the weighed value exceeds the maximum acceptable range (corresponding to red LED bar graph area).

Under-Over= (U-O) = Beeper sounds when the weighed value is outside of the Accept range (corresponding to the yellow and red LED bar graph areas)*.

***Note:** When under is indicated, the beeper signal does not sound when the pan is cleared.



Weight Display Signal

This menu item is used to define the checkweigh conditions when the LED weight display flashes as a visual alert during checkweighing.

Selections are:

OFF = LED weight display does not flash in any checkweigh condition.

Accept = LED weight display flashes when the weighed value is within the Accept range (corresponding to green LED bar graph area).

Under = LED weight display flashes only when the weighed value is below the minimum acceptable range (corresponding to yellow LED bar graph area)*.

Over = LED weight display flashes only when the weighed value exceeds the maximum acceptable range (corresponding to red LED bar graph area).

Under-Over= (U-O) = LED weight display flashes when the weighed value is outside of the Accept range (corresponding to the yellow and red LED bar graph areas)*.

***Note:** When under is indicated, the display signal does not flash when the pan is cleared.



Bar Graph Increment

This menu item is used to define how the bar graph segments are incremented during checkweighing.

Selections are:

- Scaled = Each bar graph increment is automatically calculated based on the set point entries and scaled relative to the scale capacity.
- AUTO = Each bar graph increment is automatically calculated based on the set point entries.
- User = The value of under and over bar graph increment is set by the user via the numeric keypad.

When selected, the display flashes the last Increment value entered. Enter a value within one scale division and full scale capacity.

Note: The user value can be set to represent the weight of a single item which will display as a single segment.

Graph Display

This menu item is used to define how the bar graph segments are grouped during checkweighing.

Selections are:

- Segment (SEG) = Bar graph segment light up one at a time.
- Bar = Bar graph segments light up as a continuous bar.
- Block (BLOC) = Bar graph section will light up as a single block.

END

Represents the end of the menu.

3.6.4 Print Menu

The Print Menu provides settings for printing methods and options.

 A rectangular display box containing the word "Print" in a stylized, segmented font.

RESET

This menu item is used to reset the Print menu to factory defaults. Selections are: **No**, Yes.

 A rectangular display box containing the word "RESET" in a stylized, segmented font.

Print Stable Data Only

This menu item is used to enable or disable the printing of stable values only. Selections are: **OFF**, On (default if LFT is On).

 A rectangular display box containing the text "PrintStb" in a stylized, segmented font.

Auto Print

This menu item is used to select automatic printing options. Selections are:

OFF = Auto-print feature is off.

On Stable = Prints first stable non-zero value after each change in weighing value.

Interval (INTRVL) = Prints data on user-selected intervals. This allows specifying the print interval times (in seconds from 1 to 3600).

Continuous = Prints data continuously.

On Accept = Prints after the reading becomes stable within the Accept area. (Checkweighing must be active and setup.)

 A rectangular display box containing the text "Auto-P" in a stylized, segmented font.

Print Content

This menu item is used to define the content of the printed data. Selections are:

 A rectangular display box containing the word "Content" in a stylized, segmented font.

Display = Allows printing of the displayed weight. Selections are: OFF or **On**.

 A rectangular display box containing the text "dISPLY" in a stylized, segmented font.

Numerical = Allows output of numeric data only, no additional descriptive text will be printed. Selections are: **OFF**, On.

 A rectangular display box containing the text "NUM" in a stylized, segmented font.

Header = Allows printing the pre-set header (OHAUS, Model No., and software version). Selections are:

OFF = Header data is not printed.

Single = Header data is printed only once at the very next printout*.

Cont = Header data is printed in each printout of weighing result.

 A rectangular display box containing the word "HEADER" in a stylized, segmented font.

Setpoint Data = Allows printing of the Setpoint Input values. Selections are:











OFF = Setpoint Input data is not printed.

Single = Setpoint Input data is printed once only at the very next printout*.





Cont = Setpoint Input data is printed in each printout of weighing result.

***Note:** The Single printout option is reset at each power on cycle, or if the single setting is reselected.

 A rectangular display box containing the text "SETP" in a stylized, segmented font.

Gross	=	Allows printing the Gross weight value. Selections are: OFF or On.	
Net	=	Allows printing the Net weight value. Selections are: OFF or On.	
Tare	=	Allows printing the Tare weight value. Selections are: OFF or On.	
Status	=	The status of the Checkweigh result is printed. The text "UNDER", "ACCEPT", or "OVER" is appended to the output string. (Checkweighing must be active and setup.)	
GMP	=	Access the GMP Data menu. Selections are:	
DT-TM	=	Prints GMP Date-Time menu. Selections are: OFF or On.	
USER	=	Prints GMP User ID. Selections are: OFF or On.	
PROJ	=	Prints GMP Project ID. Selections are: OFF or On.	
SCALE	=	Prints GMP SCALE ID. Selections are: OFF or On.	
NAME	=	Prints GMP Name. Selections are: OFF or On.	
PRINT	=	Access the Print GMP Print menu. Selections are:	
Off	=	GMP data is not printed.	
Single	=	GMP data is printed once only at the very next printout*.	
Cont	=	GMP data is printed in each printout of weighing result.	

***Note:** The Single printout option is reset at each power on cycle, or if the Single setting is reselected.

ACCUM	=	Access the Print Accumulation Data menu. Selections are:	
COUNT	=	When On, this prints out the number of weighments or events in Accumulation memory. Selections are: OFF or On.	
TOTAL	=	Access the Print Accumulation Total menu. When On, this prints out the total weight value in Accumulation memory. Selections are: OFF or On.	
AVG	=	When On, this prints out the calculated average weight value in the accumulation memory.	
S-DEV	=	Access the Print Accumulation Standard Deviation menu. When On, this prints out the calculated Standard Deviation. Selections are: OFF or On.	

Print Layout

This menu determines the format of data output to a printer or computer. Selections are: Format and Line Feed.



FORMAT

This menu item is used to define printing format. Selections are:

Column (COLUM) = A multi-line (single column style) printout is generated. A CRLF is added after each item.

Line = A single line printout is generated. (A TAB space is added between each item and a CRLF is used only after the very last item.



LINE FEED

This menu item is used to define form feeds. Selections are:

Off = No feeds (except for default 1 CR/LF) are appended to the printout.

4LF = 4 line feeds are appended to the printout.

Form = A form feed is appended to the printout.



List Menu Settings

This menu item is used to obtain printouts of the stored menu parameters and library data..

Selections are:

MENU = Selections are: **No**, Yes, (the information is printed immediately one time on the selection of Yes).

Library = This allows print out of the stored Library data. Selections are: **No**, Yes, (the information is printed immediately one time on the selection of Yes).



END

Represents the end of the menu.



3.6.5 Communication Menu

The Communication menu item is used to configure printing and communications parameters of the serial port. All communication is accomplished using standard ASCII characters. Characters shown in Appendix D, Table D-1, Serial Interface Command Table, are recognized by the indicator. The default serial output format is shown below.



Field:	Polarity	Space	Weight	Space	Units	Stability	CR	LF
Length:	1	1	7	1	5	1	1	1

Definitions: Polarity, "-" sign if negative, blank if positive.

Weight, up to 6 numbers and 1 decimal, right justified, leading zero blanking.

Units, up to 5 characters.

Stability, "?" character is printed if not stable, blank if stable.

Note: If the Print Content-Numeric Only is set to On, the Units and Stability fields are omitted.

Reset

This menu item is used to reset the Communication menu to factory defaults. Selections are: **No**, Yes.



Baud Rate

This menu item is used to define Baud rate. Selections are: 300, 600, 1200, 2400, 4800, **9600** or 19200.

Parity

This menu item is used to define parity. Selections are: **None**, Odd or Even.

Data Length

This menu item is used to define data length. Selections are: **7** or 8.

Stop Bit

This menu item is used to define the number of stop bits. Selections are: 1 or **2**.

Handshake

This menu item is used to define the flow control method used during serial communication. Selections are: **None** or XON/XOFF (ON-OFF).

Type

This menu is used to define the type of serial communication interface to be used. Selections are:

RS232 = Use only the default RS232 interface.

RS485 = Use the optional RS485/422 interface.

When RS485 is selected, the next sub-menu allows turning the address mode ON or OFF. The selections are:

AdrON = The user may enter a two digit address from 00 to 99. The default address is 01.

AdrOFF = The interface operation will be compatible with RS422 standards with no address requirements.

Note: During RS485 operation, the correct address must precede all data to the scale. When the scale transmits, this same address is sent out first to identify where the data string came from.

Alternate Command

This menu item is used to define alternate command characters for Print, Tare and Zero.

Select the command name, then enter the corresponding ASCII code for the desired character via the numeric keypad. Then press the **Yes** button. Refer to Table 6-2 for a list of ASCII codes and their equivalent characters.

Note: An ASCII code cannot be selected if already used for another function.

END

Represents the end of the menu.

3.6.6 I/O Menu

The I/O Menu is used to configure the optional input and output device parameters.

Reset

This menu item is used to reset the I/O menu to factory defaults. Selections are: **No**, Yes.

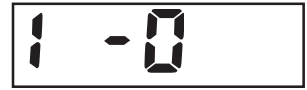

External Input

This menu item is used to define a function to be controlled by an optional external input device such as a foot switch.

Selections are:



- Off** = The external input is disabled.
- Tare = The external input initiates a Tare function.
- Zero = The external input initiates a Zero function.
- Print = The external input initiates a Print function.
- Units = The external input changes to the next available weighing unit.
- GNT = The external input simulates the function of the **G/NT** button.
- Accumulation = The external input increments a weighment totalizing function.
- Start-Stop (S-S*) = The first external input signal enables the output relay operation, (Start). The second external input signal disables the relay operation, (Stop).
- Tare-Start-Stop (T-S-S*) = The first external input signal initiates a Tare function. The second external input signal enables the output relay operation, (Start). The third external input signal disables the relay operation, (Stop).

Note: Start-Stop and Tare-Start-Stop are only available when the Relay Option is installed. When selected, pressing the **NEXT +/-** button will have the same effect as if a switching signal was received from an external device.

Input BEEP

This menu item is used to enable or disable an audible signal each time an external signal is received. Selections are: **Off**, On.



Relay Output

This menu item is used to define the relay output parameters. Selections are: Type, Sequence, Contact.



Note: If the Relay option is not installed the OUTPUT menu and associated submenus are not available for viewing or editing.

TYPE

This menu item is used to define the selection of normally open or closed relay functions.

Selections are:

- Open** = The initial state of the Relay output is normally open.
- Closed = The initial state of the Relays output is normally closed.



Note: The normally closed relay condition is only active while the Indicator is powered on. When powered off or when power is removed, the relay condition returns to a normally open condition. Restoring power to the Indicator will restore the closed condition of the relays if selected.

OUTPUT SEQUENCE

This menu item is used to define how the relay outputs sequence as the weight reading changes from under / accept / over.

Selections are:

- Normal** = The previously enabled relay will be disabled as the next relay is enabled.
- Hold** = The previously enabled relay will hold the same state as the next relay is enabled.



CONTACT

This menu item is used to define the switching operation of the relay contacts. Selections are:

- Sim** = Simultaneous. Relays open or close at the same time.
- BBM** = Break-Before-Make contact style.
- MBB** = Make-Before-Break contact style.



Note: A 100 ms delay or over-lap is used for the BBM and MBB timing.

STABLE

This menu item is used to define how the relay outputs change during instability. Selections are **Off**, **On**. When **On** is selected, relay changes are delayed until after the weight reading has become stable.



END

Represents the end of the menu.



3.6.7 GMP Data Menu

The GMP Data Menu enables the storage of identification and traceability parameters for audit trail purposes. The entered data are available for printing when turned on in the GMP Set menu 3.6.4.



Note: When there is no data entered for the User ID, Project ID, or the Scale ID, and the printing of these values has been enabled, the description text will still be printed with a long underscore line following it.

Reset

This menu item is used to reset the GMP Data menu to factory defaults.

Selections are: **NO**, Yes.



User ID

This menu item is used to enter the User identification via the numeric keypad (up to 6 characters).



Project ID

This menu item is used to enter the Project identification via the numeric keypad (up to 6 characters).



Scale ID

This menu item is used to enter the Scale identification via the numeric keypad (up to 6 characters).



Date Setup

This menu item is used to define the date parameters. Selections are: Format, Set.



FORMAT

Selections are:

- MDY = MM/DD/YY ("/" separators on printout).
- D.M.Y = DD.MM.YY ("."Separators on printout).
- YMD = YY/MM/DD ("/" separators on printout).



SET

This menu item is used to enter the current date via the numeric keypad, (example 032404 for March 24, 2004).



Note: The date is retained in memory even when power is off.

Time Setup

This menu item is used to define the time parameters. Selections are: Format, Set.



FORMAT

Selections are:

- 12hr = Set time format to 12:00 AM/PM
- 24hr = Set time format to 24:00

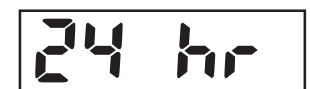

The display flashes the current time. If Time Format selected is 12hr, PM is displayed (if 24hr, skip and proceed to next menu).

SET

This menu item is used to enter the current time via the numeric keypad (example 0105 for 1:05).



Note: The time is retained in memory even when power is off.



END

Represents the end of the menu.



3.6.8 Lockout Menu

This menu is used to lock access to menus and key functions. When a menu is locked, the data can be viewed but not changed. When a key function is locked, the associated key-press is ignored. To further resist tampering, the Hardware Lock Switch on the PC board (refer to Appendix B.2) can be set to prevent changes to the Lockout Menu.

Note: If a key has been locked out, the External Input selection assigned to perform this same function is also locked out.

Lockout Menu Settings

This menu item is used to define which menus are locked or unlocked.

Selections are: Reset, Cal, Setup, Read, Mode, Print, Com, I/O, GMP Data. Reset unlocks all menus. Sub-menus selections are: **OFF** or On.



Note: Attempting to alter a locked menu will temporarily show LOC for invalid/locked entries. Only the calibration-Test function is always available.

Lockout Key Functions

This menu item is used to define which keys are locked or unlocked.

Selections are: Reset, Numeric, Clear, Target, Library, Lib Save, Next, Zero, Print, Units, GNT, Tare, Menu.

Selections are: **OFF**, On.



Note: If the menu key has been locked, it can be manually unlocked with an extended press of the **G/NT Menu** button (10 seconds). when this is done, the display shows UN-LOC momentarily then, the Menu mode can now be entered normally.

3.6.9 Hardware Lock Switch

The Hardware Lock switch may be used to add extra security to the Lockout menu settings.

When the switch is set to the LFT (LOCK) position, none of the Lockout menu settings can be changed. Refer to Appendix B.2, Figure B-1 for illustration and precaution when exposing internal components of the indicator.

4. CARE AND MAINTENANCE

4.1 Calibration

When the CKW-55 Indicator is initially set up to a base, it must be calibrated before use to ensure accurate weighing results.

CKW Scale models are shipped pre-calibrated from the factory. However, many conditions may require that the scale be recalibrated. Temperature changes, geographic gravity variations and rough handling are few reasons why a scale may need recalibration.

Notes:

1. Make sure that appropriate calibration masses are available before beginning calibration.
2. Make sure that the scale is level and stable during the entire calibration process. The Indicator will retain previously stored calibration data.
3. Masses required to perform the procedures should be in compliance with the requirements of the scale base being used with the Indicator.
4. Calibration is unavailable with LFT set to On.
5. Allow the scale to warm up for approximately 5 minutes after stabilizing to room temperature.
6. To abort calibration, press the TARE button anytime during the process.

4.1.1 Span Calibration

Span Calibration uses two points to adjust the scale. One point is called the zero value where there is no weight on the scale. The other point is the Span value that is often, but not necessarily, at full capacity. The CKW-55 Indicator allows the user to select alternate Span calibration values. Span values closest to the full scale capacity are recommended to give the best performance over the entire weighing range. Other Span values may be specified due to limited availability of calibration masses or for improved accuracy at a lower weight range. Before calibrating the scale, check that the weighing base is correctly leveled. When any selection within the Read-GMP menu is enabled, calibration results are automatically printed.

Press and hold the **G/NT Menu** button until MENU is displayed. When the **G/NT Menu** button is released, CAL is displayed.

With CAL displayed, press the **Yes** button, SPAN is displayed.

Press the **Yes** button to select and perform Span Calibration.

The display flashes 0, indicating that nothing should be placed on the platform at this time.

After ensuring that the scale platform is clear, press the **Yes** button. -C- is displayed while the zero point is established.

After a few seconds, the requested calibration value and unit (based on the Full Scale Capacity and Calibration Unit setting from the Setup Menu) flashes on the display. (This sample illustrates a Span Calibration value based on a Full Scale Capacity and Calibration Unit setting of 30 kg.)

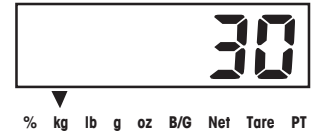

If a different Span Calibration value is desired, enter the new value via the numeric keypad. (This sample illustrates a new Span Calibration value of 15 kg.)

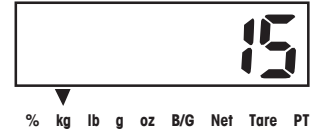

Note: Allowable range capacity 1 kilogram or 1 pound to 100% full scale are accepted, (whole numbers only). Note that values closer to the full span capacity will usually yield the most accurate calibration.

Place the corresponding mass on the platform, then press the **Yes** button. -C- is momentarily displayed while the reading is stored.



If calibration was successful, the calibration weight is displayed and the scale exits automatically to the active weighing mode. remove the weight and begin weighing operations.

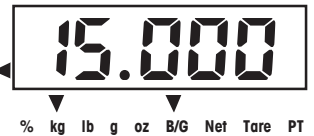

Remove the weight and begin weighing operations.

4.1.2 Linearity Calibration

Linearity Calibration uses three points, zero, mid range and full scale. The mid range value can be optionally changed by the user. Mid-range values closest to 1/2 full scale capacity are recommended to give the best performance over the entire weighing range. Before calibrating the scale, check that the weighing base is correctly leveled. When any selection within the Read-GMP menu is enabled, calibration results are automatically printed.

With CAL displayed, press the **Yes** button. SPAN is displayed. Press the **No** button to skip and proceed to the next sub-menu item LIN.



Press the **Yes** button to select and perform Linearity Calibration.

The display flashes 0, indicating that nothing should be placed on the platform at this time.



After ensuring that the scale platform is clear, press the **Yes** button. -C- is displayed while the zero point is established.



After a few seconds, the requested mid-point calibration value and unit (based on the Full Scale Capacity and Calibration Unit setting from the Setup Menu) flashes on the display. (This sample illustrates a mid-point Linearity Calibration value of 30 kg, based on a Full Scale Capacity and Calibration Unit setting of 30 kg.)

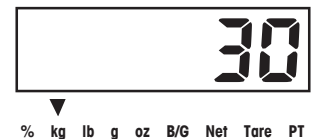

If a different mid-point Linearity Calibration value is desired, enter the new value via the numeric keypad. (This sample illustrates a new mid-point Linearity Calibration value of 20 kg.)

Note: Allowable range is 25% to 75% full scale Capacity, (whole numbers only).

Note that values closer to 1/2 full span capacity will usually yield accurate calibration.



Place the corresponding mass on the scale platform, then press the **Yes** button.-C- is momentarily displayed while the reading is stored.



After a few seconds, the requested Full Scale calibration value and unit flashes on the display. This is a fixed value based on the full scale capacity and cannot be changed. (This sample illustrates a Full Scale Linearity Calibration value based on a Full Scale Capacity and Calibration Unit setting of 30 kg.)



Place the corresponding mass on the scale platform, then press the **Yes** button. -C- is momentarily displayed while the reading is stored.



If calibration was successful, the calibration weight is displayed and the scale exits automatically to the active weighing mode. Remove the weight and begin weighing operations.

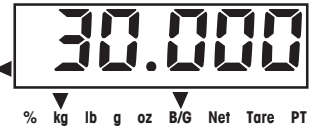

Remove the weight and begin weighing operations.

4.1.3 Calibration Test

This menu item is used to compare a known calibration mass against the calibration data stored by the Scale. When any selection within the Read-GMP menu is enabled, calibration test results are automatically printed.

Note: The Calibration Test function is available even when the CAL menu is locked out.

Press the **GNT Menu** button until MENU is displayed, CAL will be displayed. Press the **Yes** button to enter the CAL menu. Repeatedly press the **No** button until the sub-menu item CALTST is displayed. Press the **Yes** button and initiate Calibration Test.



The display flashes 0, indicating that no weight should be placed on the platform at this time.

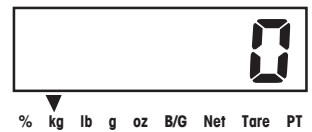

After ensuring that the scale platform is clear, press the **Yes** button. -T- is displayed while the zero point is measured.



The display flashes the calibration test mass.

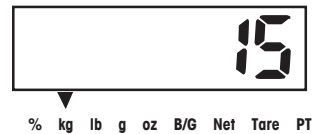

If a different calibration test mass is desired, enter the new value via the numeric keypad, (whole numbers only). (The example illustrates a new value of 10 kg.)

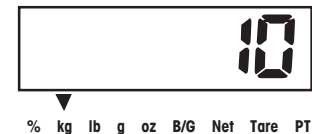

Place the corresponding test mass on the scale platform and press the yes button. -T- is momentarily displayed while the data is measured.



The display now indicates (flashes) the actual difference between the stored calibration data and the test mass data. (This example illustrates a 0.010 kg difference.)



After approximately 5 seconds, Calibration Test ends. If enabled, the result of the calibration test is printed. The scale returns to the active weighing mode and displays the current weight on the platform.



4.1.4 Geographical Adjustment Factor

This menu item is used to allow entry of values from 0 to 31 and is used to compensate for slight variations in gravity at different geographical locations around the world. (Complete Geographical Adjustment Factors are listed in Table 4-1.) The default Geo factor is 19 for Europe and 16 for USA. This feature allows authorized personnel to accurately calibrate the scale at a location other than the location where the scale is to be used. Prior to calibration, the Geo factor is set to correspond to the geographical location where the calibration is being performed. Following calibration, the Geo factor is changed to match the location where the scale is to be used. If required, the scale may also be sealed according to the required approval regulations.

Note: Only an authorized manufacturer's representative or certified verification personnel should make these changes. Changing the Geo Factor alters the calibration values.

With CAL displayed, press the **Yes** button. SPAN is displayed. Press the **No** button repeatedly to skip to the sub-menu item GEO.

Press the **Yes** button to select and access the Geo Factor menu. The current Geo Factor setting flashes on the display. (This sample illustrates the default Geo Factor setting of 19.)

If a different Geo Factor setting is desired, enter the new value via the numeric keypad. (This sample illustrates a new Geo Factor setting of 12.)

Press the **Yes** button to confirm the displayed value. The -END- is displayed.

Press **Exit** to exit to the active weighing mode.

TABLE 4-1. GEOGRAPHICAL ADJUSTMENT VALUES

Geographical latitude away from the equator, (North or South) in degrees and minutes.	Elevation above sea level in meters										
	0	325	650	975	1300	1625	1950	2275	2600	2925	3250
	325	650	975	1300	1625	1950	2275	2600	2925	3250	3575
	Elevation above sea level in feet										
0	1060	2130	3200	4260	5330	6400	7460	8530	9600	10660	11730
	1060	2130	3200	4260	5330	6400	7460	8530	9600	10660	11730
0°00' - 5°46'	5	4	4	3	3	2	2	1	1	0	0
5°46' - 9°52'	5	5	4	4	3	3	2	2	1	1	0
9°52' - 12°44'	6	5	5	4	4	3	3	2	2	1	1
12°44' - 15°06'	6	6	5	5	4	4	3	3	2	2	1
15°06' - 17°10'	7	6	6	5	5	4	4	3	3	2	2
17°10' - 19°02'	7	7	6	6	5	5	4	4	3	3	2
19°02' - 20°45'	8	7	7	6	6	5	5	4	4	3	3
20°45' - 22°22'	8	8	7	7	6	6	5	5	4	4	3
22°22' - 23°54'	9	8	8	7	7	6	6	5	5	4	4
23°54' - 25°21'	9	9	8	8	7	7	6	6	5	5	4
25°21' - 26°45'	10	9	9	8	8	7	7	6	6	5	5
26°45' - 28°06'	10	10	9	9	8	8	7	7	6	6	5
28°06' - 29°25'	11	10	10	9	9	8	8	7	7	6	6
29°25' - 30°41'	11	11	10	10	9	9	8	8	7	7	6
30°41' - 31°56'	12	11	11	10	10	9	9	8	8	7	7
31°56' - 33°09'	12	12	11	11	10	10	9	9	8	8	7
33°09' - 34°21'	13	12	12	11	11	10	10	9	9	8	8
34°21' - 35°31'	13	13	12	12	11	11	10	10	9	9	8
35°31' - 36°41'	14	13	13	12	12	11	11	10	10	9	9
36°41' - 37°50'	14	14	13	13	12	12	11	11	10	10	9
37°50' - 38°58'	15	14	14	13	13	12	12	11	11	10	10
38°58' - 40°05'	15	15	14	14	13	13	12	12	11	11	10
40°05' - 41°12'	16	15	15	14	14	13	13	12	12	11	11
41°12' - 42°19'	16	16	15	15	14	14	13	13	12	12	11
42°19' - 43°26'	17	16	16	15	15	14	14	13	13	12	12
43°26' - 44°32'	17	17	16	16	15	15	14	14	13	13	12
44°32' - 45°38'	18	17	17	16	16	15	15	14	14	13	13
45°38' - 46°45'	18	18	17	17	16	16	15	15	14	14	13
46°45' - 47°51'	19	18	18	17	17	16	16	15	15	14	14
47°51' - 48°58'	19	19	18	18	17	17	16	16	15	15	14
48°58' - 50°06'	20	19	19	18	18	17	17	16	16	15	15
50°06' - 51°13'	20	20	19	19	18	18	17	17	16	16	15
51°13' - 52°22'	21	20	20	19	19	18	18	17	17	16	16
52°22' - 53°31'	21	21	20	20	19	19	18	18	17	17	16
53°31' - 54°41'	22	21	21	20	20	19	19	18	18	17	17
54°41' - 55°52'	22	22	21	21	20	20	19	19	18	18	17
55°52' - 57°04'	23	22	22	21	21	20	20	19	19	18	18
57°04' - 58°17'	23	23	22	22	21	21	20	20	19	19	18
58°17' - 59°32'	24	23	23	22	22	21	21	20	20	19	19
59°32' - 60°49'	24	24	23	23	22	22	21	21	20	20	19
60°49' - 62°09'	25	24	24	23	23	22	22	21	21	20	20
62°09' - 63°30'	25	25	24	24	23	23	22	22	21	21	20
63°30' - 64°55'	26	25	25	24	24	23	23	22	22	21	21
64°55' - 66°24'	26	26	25	25	24	24	23	23	22	22	21
66°24' - 67°57'	27	26	26	25	25	24	24	23	23	22	22
67°57' - 69°35'	27	27	26	26	25	25	24	24	23	23	22
69°35' - 71°21'	28	27	27	26	26	25	25	24	24	23	23
71°21' - 73°16'	28	28	27	27	26	26	25	25	24	24	23
73°16' - 75°24'	29	28	28	27	27	26	26	25	25	24	24
75°24' - 77°52'	29	29	28	28	27	27	26	26	25	25	24
77°52' - 80°56'	30	29	29	28	28	27	27	26	26	25	25
80°56' - 85°45'	30	30	29	29	28	28	27	27	26	26	25
85°45' - 90°00'	31	30	30	29	29	28	28	27	27	26	26

4.1.5 GMP Calibration Printout

If any setting in the Print-Content-GMP menu (refer to Section 3.6.4 Print Menu) is turned on, GMP automatically prints the calibration data after calibration or calibration test is completed. Other GMP data, if turned on, will also be printed as shown.

Span Calibration Printout

When performing a Span calibration with any GMP setting turned on, a printout is automatically made after the procedure is completed.

```

----- SPAN CAL -----
Cal:          40 kg
Old:          39.99 kg
Diff:         0.01 kg
Wt. Ref. _____

12/01/04  1:10:00 PM
USER ID 654321
PROJ ID 111111
SCALE ID 123456
Name _____
----- END -----
    
```

Linearity Calibration Printout

When performing a Linearity calibration with any GMP setting turned on, a printout is automatically made after the procedure is completed.

```

----- LIN CAL -----
Cal:          40 kg
Old:          39.99 kg
Diff:         0.01 kg
Wt. Ref. _____

12/01/04  1:10:00 PM
USER ID 654321
PROJ ID 111111
SCALE ID 123456
Name _____
----- END -----
    
```

Calibration Test Printout

When performing a Calibration Test with any GMP setting turned on, a printout is automatically made after the procedure is completed.

```

----- CAL TEST -----
Test:         10 kg
Act:          10.01 kg
Diff:         0.01 kg
Wt. Ref. _____

12/01/04  1:30:00 PM
USER ID 654321
PROJ ID 111111
SCALE ID 123456
Name _____
----- END -----
    
```

4.2 Cleaning

To keep the Indicator and scale operating properly, the housing should be kept clean and free from foreign material.

- The components should be kept clean and free of excessive material build up.
- The platform can be cleaned using most standard food processing equipment methods (such as high-pressure water or steam)
- Avoid directly spraying the load cell with high-pressure water jets
- Do not use strong alkalis, solvents or abrasive materials and chemicals
- The platform extends past the bottom plate to minimize entry of water or foreign material into the frame. As necessary, remove the platform to wipe or wash down the internal surfaces of the base.
- Removable components such as the weighing platform, leveling feet and rubber load pads (including column and CKW-55 Indicator when purchased as a scale system) may be removed and cleaned

4.3 Troubleshooting

TABLE 4-2. TROUBLESHOOTING.

SYMPTOM	PROBABLE CAUSE(S)	REMEDY
Unit will not turn on.	Power cord not plugged in or properly connected. Power outlet not supplying electricity. Battery power used up. Other failure.	Check power cord connections. Make sure power cord is plugged in properly into the power outlet. Check power source. Reconnect AC power to charge the battery. Service required.
Cannot zero the Scale, or will not zero when turned on.	Load on Scale exceeds allowable limits. Load on Scale is not stable. Load Cell damage.	Remove load on Scale. Wait for load to become stable. Service required.
Unable to calibrate.	Lock Calibration Menu set to On. LFT menu set to On. Incorrect value for calibration mass.	Set Lock Calibration Menu to Off. Refer to Section 3.6.8 Lockout Menu. Set LFT menu to Off. Use correct calibration mass.
Cannot display weight in desired weighing unit.	Desired unit setting not set to On.	Enable desired unit in the Units Menu (refer to Section 3.6.2 in the Readout Menu).
Cannot change menu settings.	Menu has been locked.	Set selected menu to Off in the Lock Menu. Lockout Switch on the circuit board may need to be set to the Off position.
Err 1	Overload condition.	Weight on platform exceeds scale capacity. Remove excess weight from the platform. Increase Full Scale Capacity setting if possible.
Err 2	Underload condition	Replace pan if removed. Cycle power to scale to clear power-on Zero.

TABLE 4-2. TROUBLESHOOTING (Cont.).

SYMPTOM	PROBABLE CAUSES(S)	REMEDY
Err 7	EEPROM data incorrect	Service required.
Err 10	Library or RTC data incorrect	Replace RTC (Lithium) back-up battery.
Err 14	Zero value exceeds the Zero % setting	Remove excess dead load from platform. Select a higher Zero Range value, (Non-LFT only.)
Err 21	Calibration incorrect.	Perform the recalibration using correct masses.
Lo bAt	Batteries are weak.	Less than 20 minutes of operating time remaining. Reconnect AC power to charge the battery. If battery remains weak even after a full charge cycle, replace the battery pack.
CLr.PAn (Err 3)	Power on zero exceeds $\pm 10\%$ of original calibration zero.	Clear pan of excess masses, or recalibrate to establish a new zero point. Note: After several seconds, Non-LFT units will accept the new zero point. LFT enabled units may change to Err 3 if condition is not corrected.

4.4 Service Information

If the Troubleshooting section does not resolve or describe your problem, you will need to contact an authorized Ohaus Service Agent. For Service assistance in the United States, please call Aftermarket, Ohaus Corporation toll-free at (800) 526-0659. An Ohaus Product Service Specialist will be available to help you.

4.5 Battery Replacement

The Indicator contains a small Lithium battery to maintain a real-time clock and a memory backup system. This battery should provide many years of maintenance free operation.

The CKW Indicator may also have an optional rechargeable battery system installed, (purchased separately). This option includes a long life NiMH battery pack and a charging circuit board. This battery system allows operation of the Indicator without an AC power connection.

In the event that either battery requires replacement, please note the following safety precautions:

CAUTION! : RISK OF EXPLOSION IF BATTERY IS REPLACED WITH WRONG TYPE OR CONNECTED IMPROPERLY. SEE SERVICE MANUAL FOR INSTRUCTIONS. DISPOSE OF BATTERY ACCORDING TO LOCAL LAWS AND REGULATIONS.

Attention! : Risque d'explosion si la batterie est remplacée par un type inapproprié ou si elle est incorrectement branchée. Voir le manuel technique de réparation pour des instructions. Jeter la batterie conformément aux lois et règlements locaux.

4.5.1 Lithium Battery Replacement:

Some symptoms of a low Real-Time Clock (RTC) battery condition include: A display of Err 10 at power-on, an incorrect time or date printout, loss of library or accumulation data.

Battery replacement should only be done by qualified service personnel. To replace the lithium battery, the Indicator housing needs to be opened. Before continuing, remove power from the scale and remove all external AC power connections to the Indicator. If the Indicator contains a rechargeable battery system, be sure that the **ON/ZERO Off** button is used to turn off the scale after removing the AC power plug.



CAUTION: ELECTRICAL SHOCK HAZARD. REMOVE ALL POWER CONNECTIONS TO THE INDICATOR BEFORE SERVICING OR MAKING INTERNAL CONNECTIONS. THE HOUSING SHOULD ONLY BE OPENED BY AUTHORIZED AND QUALIFIED PERSONNEL, SUCH AS AN ELECTRICAL TECHNICIAN.

The Real-Time Clock, (RTC) battery is a 3V lithium "coin" cell. The recommended battery type is CR2032. Refer to figure 4-1, remove the old battery as shown by pressing down on the Retaining Clip and sliding the battery up and out of the holder.

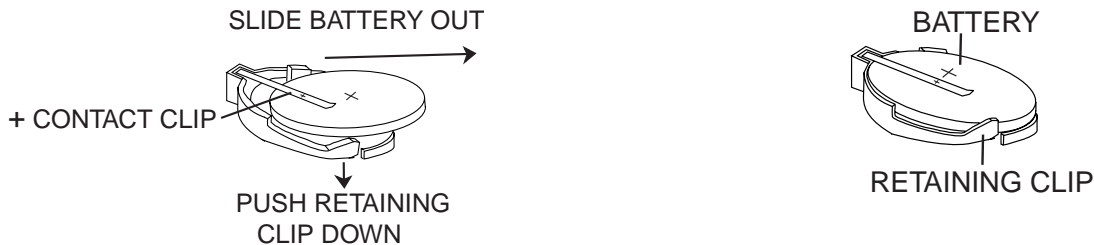

Figure 4-1. RTC Battery Removal/Installation.

To install a new battery into the holder, hold the battery with the "+" mark facing up. Slide the battery under the Contact Clip until the Retaining Clip springs up and locks the battery in place.



CAUTION: Do not dispose of used batteries in normal trash. Follow the proper disposal or recycling requirements in accordance with local laws and regulations.

4.5.2 Rechargeable NiMH Battery Replacement:

After a long service life, a reduction in battery operating time may be experienced. The end of the NiMH battery's useful life may be indicated by a "Lo bat" display occurring very shortly after a complete charge cycle, or by a red flashing LED during the charge sequence indicating a charging error.

The NiMH battery pack is a sealed package. Single cells are not replaceable. A battery replacement kit is available from your dealer, (refer to section 6 Accessories and Options for part number information). Replacement instructions are included with the battery kit.



CAUTION: Do not dispose of used batteries in normal trash. Follow the proper disposal or recycling requirements in accordance with local laws and regulations.

5. TECHNICAL DATA

5.1 Drawings and Dimensions

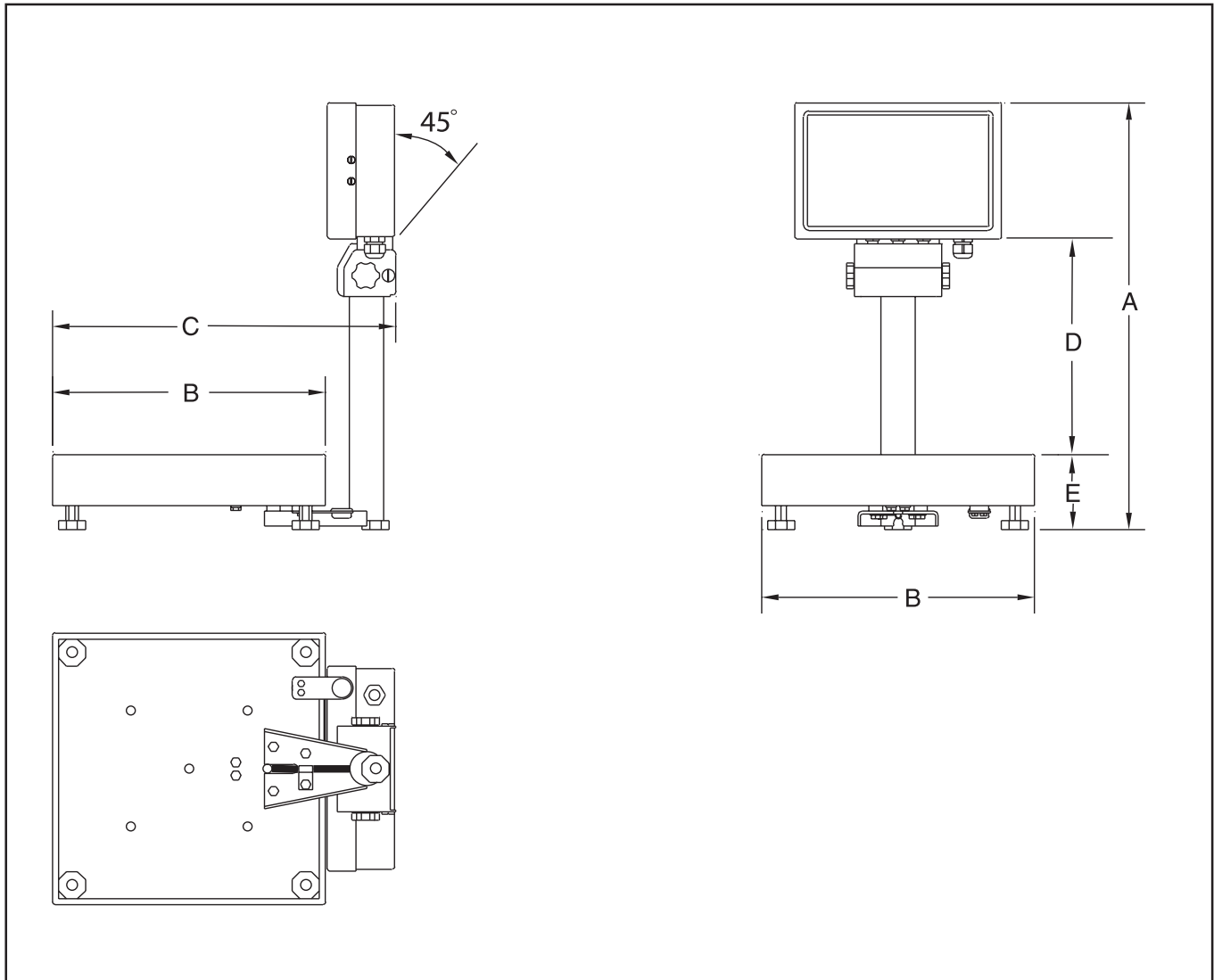

Figure 5-1. CKW Series Scale.

TABLE 5-1. DIMENSIONS

Base	A Overall Height	B Overall Width	C Overall Depth	D Distance from Pan to bottom of Indicator	E Distance from Table to surface of Pan
CKW3R, CKW6R	459mm 18.1"	254mm 10"	335mm 13.2"	231mm 9.1"	84mm 3.3'
CKW15L	459mm 18.1"	305mm 12"	383mm 15.1"	231mm 9.1"	84mm 3.3'
CKW30L	459mm 18.1"	305mm 12"	383mm 15.1"	215mm 8.5"	92mm 3.6'

5.1 Drawings and Dimensions (Cont.)

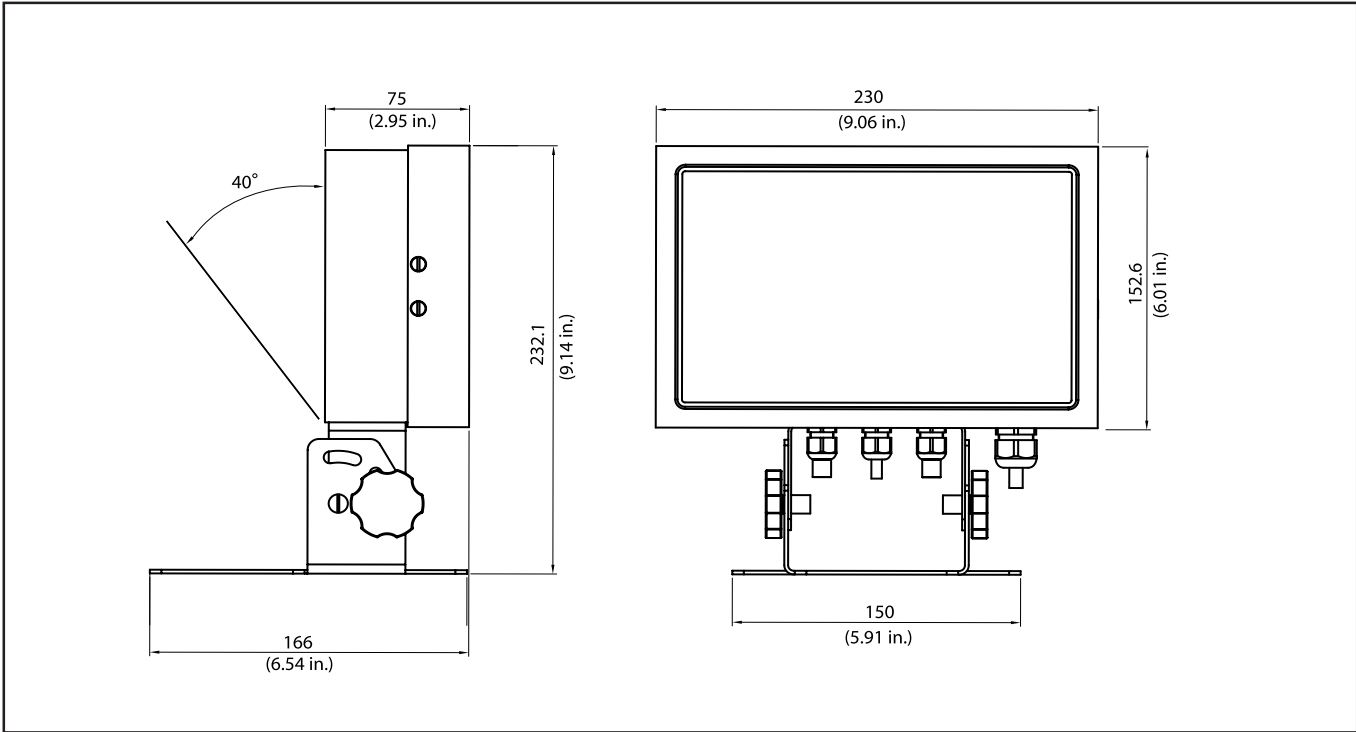

Figure 5-2. CKW-55 Indicator Table Mount Position.

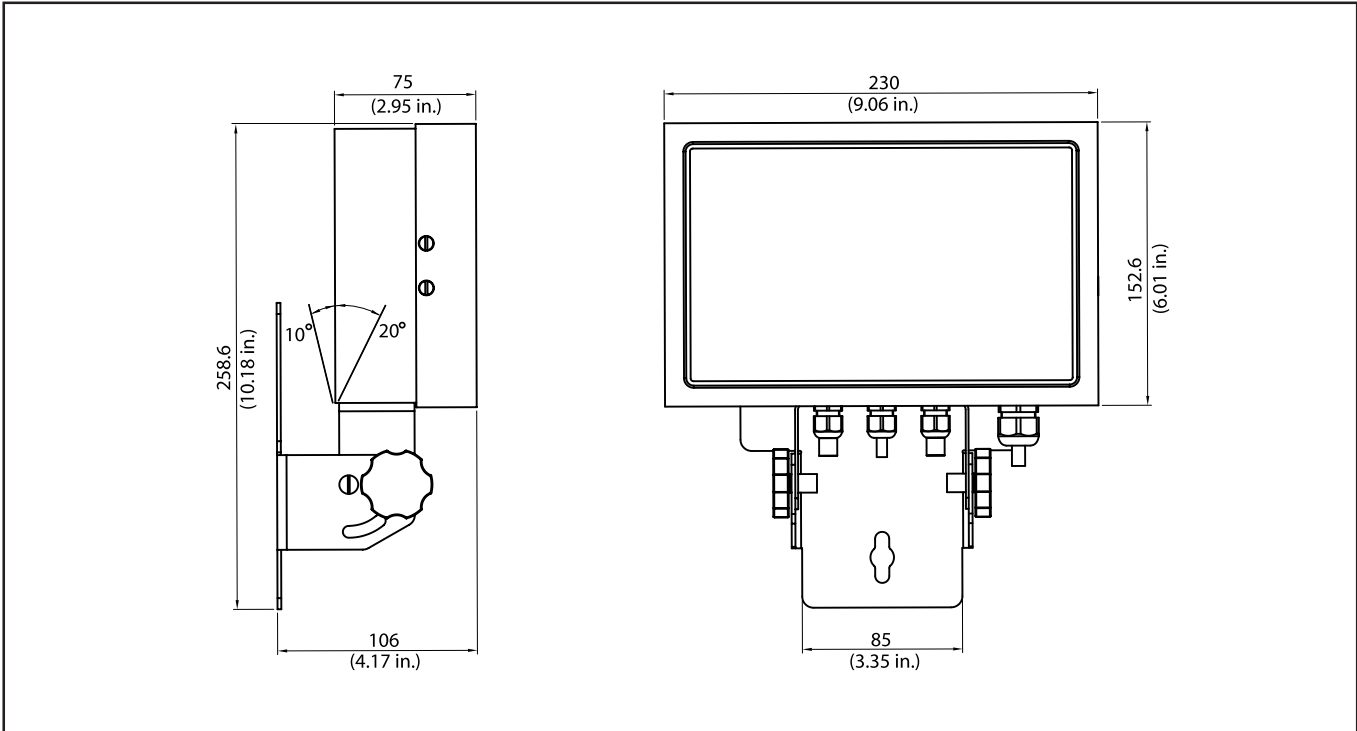

Figure 5-3. CKW-55 Indicator Wall Mount Position.

5.2 Technical Data

Materials

Housing: stainless-steel Base: Stainless Steel
Keypad/display overlay: polyester Feet: Rubber

Ambient conditions

The technical data is valid under the following ambient conditions:

Ambient temperature: -10°C to 40°C / 14°F to 104°F
Relative humidity: Maximum relative humidity 80% for temperatures up to 31°C decreasing linearly to 50% relative humidity at 40°C.

Height above sea level: up to 4000m

Operability is assured at ambient temperatures between -10°C. and 40°C.

5.3 Specifications

INDICATOR	CKW-55			
Maximum Displayed Resolution	1:20,000			
Approval Resolution	1:10,000			
Weighing Units	kg, lb, g, oz, lb:oz, %			
Functions	Static Weighing, Checkweighing, Accumulation			
Weight Display	0.8" / 20 mm High 6-digit, 7-segment LED with Adjustable Brightness Control			
Checkweigh Indication	24-segment LED (3 color x 8) Bar Graph and Audible Beeper with Multiple User Setups			
Keyboard	7-Function, 12-Numeric with dedicated Tare and Target Entry Buttons			
Construction and Protection	Stainless Steel NEMA 4X / IP66			
Load Cell Excitation Voltage	5V DC			
Load Cell Input Sensitivity	2 or 3 mV/V			
Load Cell Drive	Up to 4 x 350 ohm Load Cells			
Stabilization Time	Within 2 Seconds			
Auto-zero Tracking	Off, .5, 1 or 3 Divisions			
Zeroing Range	2%, 18% or 100% of Capacity			
Span Calibration	1 kg or 1 lb to 100% Capacity			
Overall Dimensions (W x D x H)	230 x 75 x 217 mm / 9" x 3" x 8.5" (includes bracket)			
Net Weight	3.0 kg / 6.61 lb			
Shipping Weight	4.6 kg / 10.14 lb			
Operating Temperature Range	-10°C to 40°C/14°F to 104°F			
Power	100-240 VAC / 50-60 Hz Universal Power Supply, Hardwire Cord, Optional Internal Rechargeable NiMH Battery (10-hour typical life)			
Interface	Built-in RS232 and External Input / Optional: RS422/485, Relay Output			
SCALE MODEL	CKW3R55	CKW6R55	CKW15L55	CKW30L55
Capacity x Enhanced Readability	3 kg x 0.0005 kg 3000 g x 0.5 g 6 lb x 0.001 lb 96 oz x 0.02 oz 6 lb x 0.02 oz (lb:oz)	6 kg x 0.001 kg 6000 g x 1g 15 lb x 0.002 lb 240 oz x 0.05 oz 16 lb x 0.05 oz (lb:oz)	15 kg x 0.002 kg 15000 g x 2 g 30 lb x 0.005 lb 480 oz x 0.1 oz 30 lb x 0.1 oz (lb:oz)	30 kg x 0.005 kg 30000 g x 5 g 60 lb x 0.01 lb 960 oz x 0.2 oz 60 lb x 0.2 oz (lb:oz)
Maximum Resolution	1:6000	1:7500	1:7500	1:6000
Capacity x Approvable Readability	3 x 0.001 kg 3000 x 1 g 6 x 0.002 lb 96 oz x 0.05 oz	6 x 0.002 kg 6000 x 2 g 15 x 0.005 lb 240 oz x 0.02 oz	15 x 0.005 kg 15000 x 5 g 30 x 0.01 lb 480 oz x 0.2 oz	30 x 0.01 kg 30000 x 10 g 60 x 0.02 lb 960 oz x 0.5 oz
Approval Resolution	1:3000	1:3000	1:3000	1:3000
Column	Tubular 304 Stainless Steel 11.8" / 300 mm Fixed Height with Indicator and Base Mounting Brackets			
Net Weight	8.7 kg / 19.2 lb	9.8 kg / 21.7 lb	11.9 kg / 26.3 lb	12.9 kg / 28.5 lb
Shipping Weight	12 kg / 25 lb	13 kg / 28 lb	15 kg / 32 lb	16 kg / 35 lb

6. ACCESSORIES AND OPTIONS

TABLE 6-1. ACCESSORIES AND OPTIONS.

DESCRIPTION	PART NUMBER
Wall/Table Mount Kit	71167964
Column Mount Kit	71167972
RS232 Cable/Printer SF42	80500574
RS232 Cable/PC 25-pin	80500553
RS232 Cable/PC 9-pin	80500552
SF42 Printer	SF42
External Foot Switch	71173378
Rechargeable Battery Kit	71167966
Replacement NiMH Battery	71172942
RS422/485 Interface Kit	71167965
AC Relay Kit	71167967
DC Relay Kit	71173377

6.1 Available Options

6.1.1 Relay Option

When installed, the Relay option board is detected by the software. During the display sequence the message REL OPT is displayed to confirm the detection of this option.

For more information refer to the instruction manual included with the Option Kit when purchased.

6.1.2 RS485/422 Option

When installed, the RS485/422 option board is detected by the software. During the power on display sequence the message 485 OP is displayed to confirm the detection of this option.

For more information refer to the instruction manual included in the Option Kit when purchased.

6.1.3 Rechargeable Battery Option

When installed, the Rechargeable Battery Option board is detected by the main board software. During the power display sequence, the message BAT OP is displayed to confirm the detection of this option.

For more information refer to the instruction manual included in the Option Kit when purchased.

TABLE 6-2. ASCII NUMBER TO CHARACTER CONVERSION.

<u>ASCII</u>	<u>Character</u>	<u>ASCII</u>	<u>Character</u>	<u>ASCII</u>	<u>Character</u>
032	space	064	@	096	`
033	!	065	A	097	a
034	^	066	B	098	b
035	#	067	C	099	c
036	\$	068	D	100	d
037	%	069	E	101	e
038	&	070	F	102	f
039		071	G	103	g
040	(072	H	104	h
041)	073	I	105	i
042	*	074	J	106	j
043	+	075	K	107	k
044	,	076	L	108	l
045	-	077	M	109	m
046	.	078	N	110	n
047	/	079	O	111	o
048	0	080	P	112	p
049	1	081	Q	113	q
050	2	082	R	114	r
051	3	083	S	115	s
052	4	084	T	116	t
053	5	085	U	117	u
054	6	086	V	118	v
055	7	087	W	119	w
056	8	088	X	120	x
057	9	089	Y	121	y
058	:	090	Z	122	z
059	;	091	[123	{
060	<	092	\	124	
061	=	093]	125	}
062	>	094	^	126	~
063	?	095	_	127	□

A. MAKING CONNECTIONS TO THE INDICATOR

The CKW-55 Indicator housing contains 4 liquid-tight connectors at the bottom for external cabling. Figure A-1 illustrates the locations of the liquid tight connectors.

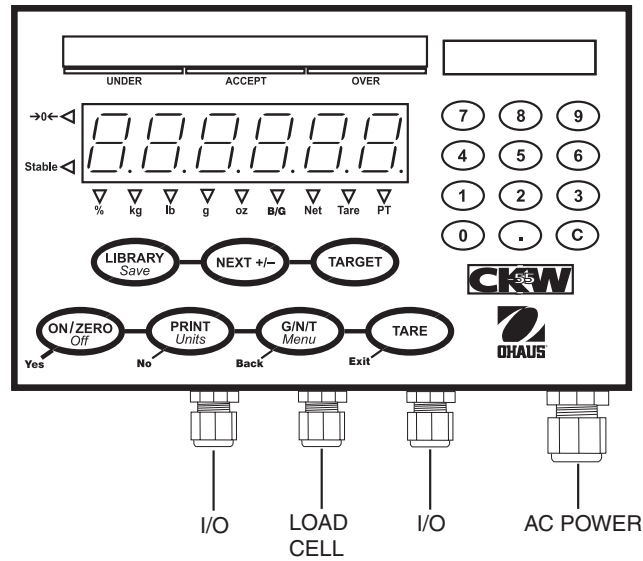

Figure A-1. Cable Entry Identification.

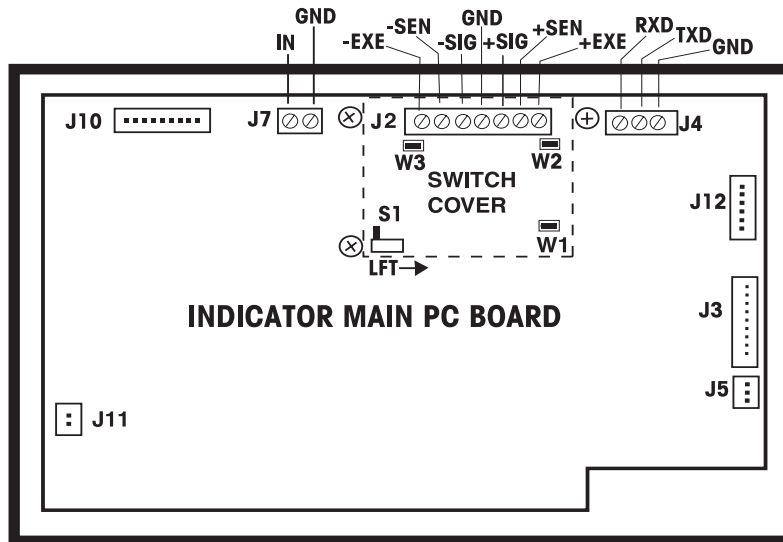

Figure A-2. Printed Circuit Board Connections.

A.1 LOAD CELL CONNECTIONS

Figure A-2 illustrates the locations of the printed circuit board connections.



CAUTION: ELECTRICAL SHOCK HAZARD. REMOVE ALL POWER CONNECTIONS TO THE INDICATOR BEFORE SERVICING OR MAKING INTERNAL CONNECTIONS. THE HOUSING SHOULD ONLY BE OPENED BY AUTHORIZED AND QUALIFIED PERSONNEL, SUCH AS AN ELECTRICAL TECHNICIAN.

Unfasten the four side screws of the indicator housing. Pull the front cover forward. Pass the load cell cable through the liquid-tight connector at the bottom and center of the housing. Pass the cable through the large ferrite bead that is attached to the internal plastic clip.

Remove the 3 screws securing the switch cover over Terminal Strip J2. Refer to the manufacturer's wiring code of the load cell cable and connect the wires to Terminal Strip J2 according to the proper signal name. See Figure A-2. Tighten all terminal screws securely.

A.2 JUMPER POSITIONS

When connecting a 2 mv/v load cell: Jumper W1 is to be left in place shorting the two pins. See Figure A-3.

When connecting a 3 mv/v load cell: Jumper W1 must be removed or left in place with one pin uncovered.

When connecting a 4-wire load cell with no sense wires: Jumpers W2 and W3 must be left in place shorting the two pins.

When connecting a 6-wire load cell that includes sense wires, Jumpers W2 and W3 must be removed.

When connecting a load cell with an extra ground shield wire: The shield wire may be connected to the center position of J2.

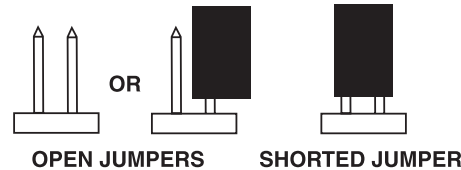

Figure A-3. Open and Shorted Jumpers.

After wiring is completed and jumpers are in place, replace the switch cover and securing screws on the main PC board. Replace the indicator housing screws. Make sure the liquid-tight connector is properly tightened.

A.3 INTERFACE CONNECTIONS



CAUTION: ELECTRICAL SHOCK HAZARD. REMOVE ALL POWER CONNECTIONS TO THE INDICATOR BEFORE SERVICING OR MAKING INTERNAL CONNECTIONS. THE HOUSING SHOULD ONLY BE OPENED BY AUTHORIZED AND QUALIFIED PERSONNEL, SUCH AS AN ELECTRICAL TECHNICIAN.

A.3.1 Connecting RS232 Interface Cable

The CKW-55 Indicator is equipped with a bidirectional RS232 interface for communication with external printers or computers. All communication is accomplished using standard ASCII format. Only two signal wires and ground are required, hardware handshaking signals are not used. To connect the RS232 cable, proceed as follows:

- Unfasten the side screws of the indicator housing and remove the front cover by pulling forward.
- Pass the communication cable through one of the I/O liquid-tight connectors at the bottom of the indicator housing.
- Match the wire signals to connector J4 on the main PC board and connect the cable accordingly. See Figure A-2.
- Connect the opposite end of the communication cable to the communication device.
- Reinstall the front cover and make sure the liquid-tight connector is tight.
- Refer to Section 3.6.5 to set up the proper communication parameters.

Note: When the optional RS485/422 Interface is installed, the RS232 Interface cannot be used.

A.3.2 Connecting External Input Device (Not supplied)

The CKW-55 Indicator has provisions to connect an external input device such as a foot switch (purchased separately) to provide a selected function. The selected function can be set in the I/O menu, (see section 3.6.6 when the indicator is fully functional). The external device must provide a normally open (N.O.) momentary switch contact.

To connect the interface cable, proceed as follows:

- Unfasten the side screws of the indicator housing and remove the front cover by pulling forward.
- Pass the remote cable through one of the I/O liquid-tight connectors at the bottom of the indicator housing.
- Connect the cable to connector J7 on the main PC board. See Figure A-2.
- Re-install the front cover and make sure the liquid-tight connector is tight.

B. LEGAL FOR TRADE

Before this product can be used in legal-for-trade or legally controlled applications, it must be inspected in accordance with local Weights and Measures or approval agency regulations. It is the responsibility of the purchaser to ensure that all pertinent legal requirements are met. Please contact your local Weights and Measures office or authorized manufacturer’s representative for further details.

LFT or legally controlled operation is possible through the Setup Menu and can be secured using an internal hardware switch located on the PC board. Access to the hardware switch may be denied using additional mechanical methods. The scale must have been calibrated prior to performing this procedure.

This procedure must only be performed by authorized personnel.

B.1 Setup Procedure

Set up the scale, and perform an accurate calibration. If required, use the LOCK menu to lock out changes to any additional menu items, (Refer to Section 3.6.8, Lock Menu). In the Setup menu, set Legal-For-Trade to On (Refer to Section 3.6.1).

Note: If the scale has been previously set for Legal For Trade operation, it will be necessary to remove the seal and set the LFT switch Off before proceeding. Removal of the existing seal will make the scale legally unusable for Legal for Trade use until a new seal is put into place

B.2 Locking Metrological Parameters

To prepare the scale for Legal For Trade operation, it is necessary to set the internal LFT switch on. To access the switch, first remove all AC power from the scale system. On the scale containing an optional rechargeable battery system, set the scale Off using the **ON/ZERO/OFF** button.



CAUTION: ELECTRICAL SHOCK HAZARD. REMOVE ALL POWER CONNECTIONS TO THE INDICATOR BEFORE SERVICING OR MAKING INTERNAL CONNECTIONS. THE HOUSING SHOULD ONLY BE OPENED BY AUTHORIZED AND QUALIFIED PERSONNEL, SUCH AS AN ELECTRICAL TECHNICIAN.

Remove the four flat head screws at the left and the right sides of the Indicator housing and pull the front panel of the Indicator forward. Remove the internal cover plate by removing the 3 screws at the corners, (Refer to Figure B-1). One of screws has a countersink washer. This washer may be used as part of the mechanical seal.

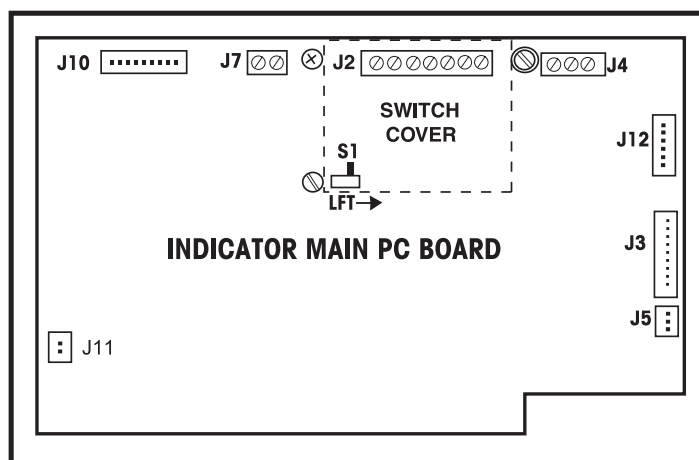

Figure B-1. Inside the Indicator Cover.

B.2 Locking Metrological Parameters (Cont.)

Position the LFT switch (S1) to the direction shown by the arrow. (Refer to Figure B-1.) With this change, the Legal For Trade menu setting and all LOCK menu settings now become non-alterable.

Reinstall the cover plate. Install the 3 screws to their original position. Reposition the front housing and reinstall the 4 screws at the sides of the Indicator housing.

B.3 Verification

Prior to the mechanical sealing, the scale should be inspected for correct operation by an authorized Weights & Measures representative.

The Legal For Trade setup can be verified during power on display sequence. When both the Legal For Trade menu setting and the LFT switch have been enabled, the message LFT ON will be briefly shown. (If only the LFT switch has been enabled, the message LOC ON will be shown.)

B.4 Sealing

Four different methods are available for sealing. The method used will depend on the scale application and the requirements of the local Weight and Measures regulations.

Internal sealing may be required in applications where an external mechanical seal would be impractical or disallowed. Internal sealing allows for more frequent internal inspection and cleaning of the Indicator housing.

External sealing may be used where complete access to the internal Indicator housing needs to be restricted. If the housing needs to be opened frequently, this method may not be efficient unless authorized personnel are available to reseal the housing each time.



CAUTION: ELECTRICAL SHOCK HAZARD. REMOVE ALL POWER CONNECTIONS TO THE INDICATOR BEFORE SERVICING OR MAKING INTERNAL CONNECTIONS. THE HOUSING SHOULD ONLY BE OPENED BY AUTHORIZED AND QUALIFIED PERSONNEL, SUCH AS AN ELECTRICAL TECHNICIAN.

B.4 Sealing (Cont.)

Internal Sealing

When the internal sealing method is used, first remove all AC power from the scale system. On scales containing an optional rechargeable battery system, set the scale Off using the **ON/ZERO Off** button. Remove the four flat head screws at the left and right sides of the Indicator housing and pull the front panel of the Indicator forward. There are two different methods for the internal seal, a crimped wire seal or a tamper evident label. The LFT kit supplied with the Indicator contains the wire seal components.

Wire Sealing

Refer to Figure B-2 and seal the Cover Plate as shown.

IMPORTANT: Trim any excess wire length protruding from the crimp seal to prevent the wire from touching the printed circuit board.

Make sure the internal sealing gasket is in place and unobstructed. Assemble the Indicator and replace the screws on both sides of the housing.

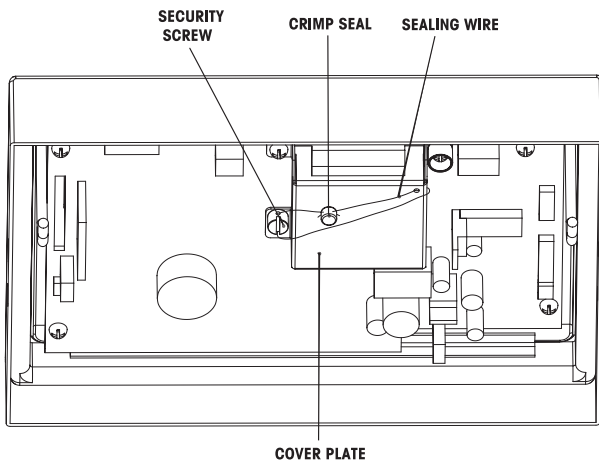

Figure B-2. Internal Wire Seal.

Tamper Proof Adhesive Sealing

Refer to Figure B-3 and seal the Cover Plate by placing a sealing label as shown over the security washer and security screw. Make sure the internal sealing gasket is in place and unobstructed. Assemble the Indicator and replace the screws on both sides of the housing.

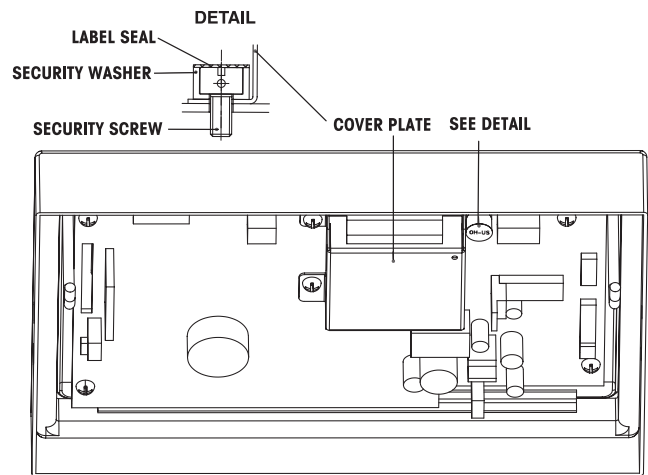

Figure B-3. Internal Sealing Label.

B.4 LFT Sealing (Cont.)

External Sealing

There are two different methods for external sealing, a crimped wire seal, and the application of a tamper proof label.

Wire Sealing

Remove the two flat head screws from one side of the Indicator housing. Replace these screws using the two security screws from the Weights and Measures kit. Using the crimp seal and wire, seal the Indicator as shown in Figure B-4.

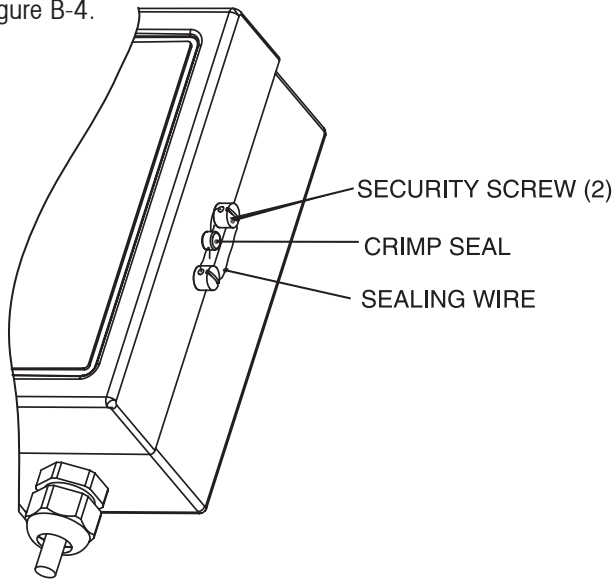

Figure B-4. External Wire Seal.

Tamper Proof Label Sealing

Place an adhesive seal over one of the flat head screws at the side of the Indicator housing. An alternative larger label seal, can be used to cover one or more of the side screws and the housing edges. See Figure B-5.

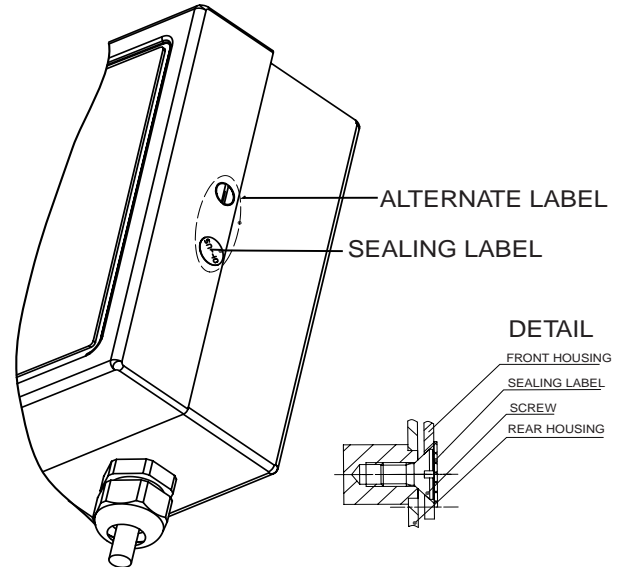

Figure B-5. External Sealing Label.

C. CKW INDICATOR MOUNTING

When purchased as an Indicator only configuration, the CKW Indicator is supplied with a Wall/Table mounting Bracket.

The bracket allows the Indicator to be mounted to a vertical wall surface or to a table or other appropriate flat horizontal surface.

For best performance, the bracket should be mounted to a solid surface using appropriate hardware, (not supplied).

The sides of the Wall/table mount bracket contain slots that allow the user to adjust the angle of the Indicator for best viewing. The bracket has two sets of slots. One slot is utilized in the wall mount position, the other in the table mount position. A separation between the two slots prevents the Indicator from falling excessively in either direction in the event that the adjustment knobs are not fully secured.

When purchased, the Indicator and bracket are assembled in the wall mount position. To change the assembly to the table mount position, remove the two side adjustment knobs, reposition the indicator to a perpendicular orientation to the bracket, reinstall the side adjustment knobs.

The mounting holes in the bracket are of a teardrop shape that will allow for easy removal after mounting. One mounting hole in the bracket has a double-sided tear drop shape. By installing a screw at the furthest edge of this hole, the bracket can be made to have a more permanent and secured mounting, (see Figure C-1).

The mounting holes will accommodate up to 6 mm (1/4") bolts or screws. The head diameter should be no less than 9mm (0.35"). When mounting into solid material the hardware should be at least 25mm (1") in length.

When mounting the Indicator bracket to hollow wallboard or masonry materials, first install appropriate anchoring hardware into the material.

The Indicator can weigh up to 3.2 kg (7 lbs) with included options. The mounting hardware should be capable of supporting well in excess of this amount.

Use the mounting bracket as a template for marking hole positions on the surface where the Indicator is to be mounted. Dimensions are also given in Figure C-1 to locate the holes without using the bracket as a template. Drill pilot holes for the hardware that are appropriate for the bolt or screw size being used.

After mounting the Indicator, loosen the adjustment knobs, position the Indicator angle for best viewing from the operator's position, retighten the adjustment knobs. Also check that the pivot screw located behind the adjustment knob does not become excessively loose after several angle adjustments, retighten as necessary.

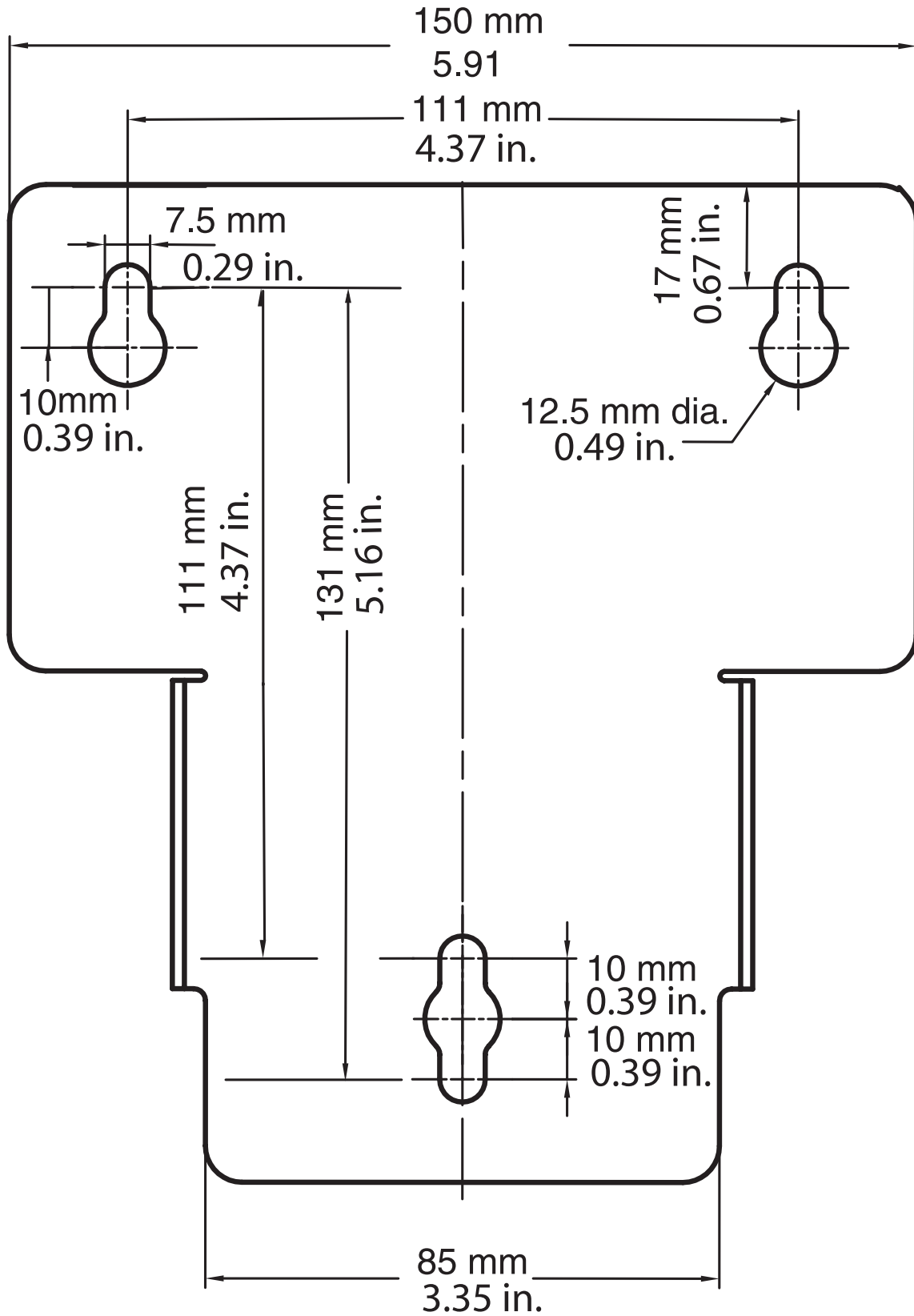

Figure C-1. Mounting Bracket Dimensions.

D. SERIAL COMMUNICATION

The CKW Indicator contains an RS232 serial communication interface. This interface gives the user a method to connect to a computer or printer. With this connection, the user can create printed records of weighing data and have some automated control over the Indicator's operation. (For example, the downloading of new checkweigh parameters can be done through the interface.)

The interface uses a simple three-pin connection. Due to this simplicity, no hardware flow control is provided. Minimal software flow control (handshake) is provided by an optional menu setting of the "Xon/Xoff" parameter. The setup of other RS232 operating parameters are more fully explained in section 3.6.5. The physical hardware connection is explained in in Appendix A, section A.3.1.

The available RS232 commands are listed in Table D-1 below.

D.1 Interface Commands

TABLE D-1. SERIAL INTERFACE COMMAND TABLE.

Command Character	Description
PU	Print current weighing unit: kg, g, lb, oz, lb:oz, %.
P	Same as pressing PRINT button.**
T	Same as pressing TARE button.**
Z	Same as pressing ZERO button.**
xS	Enable print stable data only. Where x=0 for Off, x=1 for On.
xP	Auto print condition. Where x = 1 to 3600 second intervals, x=0 for Off, x=C for Continuous, x=S for On Stable.
xCM	Checkweigh Input Mode, where x=0 for Range, 1=Variance, 2=Percent (%).
xCU	Set Under value, as a Range, Variance or Percent value (depending on Checkweigh Input Mode setting).*
xCO	Set Over value, as a Range, Variance or Percent value (depending on Checkweigh Input Mode setting).*
xCT	Set Target value (used only in Variance and Percent Input Modes, not used in range Mode)*.
xU	Set weighing unit: Where x=1 to 6, 1=g, 2=kg, 3=lb, 4=oz, 5=lb:oz, 6=%, if x=blank, then increment to next available mode. (The unit can not be selected if it is not enabled).
PV	Print model name, software revision, and LFT status - if on, (eg. "CKW-55 Sr 1.0 LFT "On", or "CKW-55 Sr 1.1"
xT	Set a pre-tare value of x, in present weighing units.* (Positive values only)

* Up to 6 numeric characters, an optional "-" sign, and single decimal point (e.g., 1.000CU, 2:3.2CU) Use colon ":" as a separator for lb:oz data entry.

** Alternate characters can be assigned for Print, Tare and Zero as described under Alternate Command Characters in section 3.6.5.

Notes:

- Commands sent to the indicator must be terminated with a carriage return (CR) or carriage return-line feed (CRLF).
- Data output by the indicator is always terminated with a carriage return-line feed (CRLF).

E. CAPACITY AND GRADUATION TABLE

TABLE E-1. TABLE OF TYPICAL CAPACITY AND GRADUATION VALUES

Full Scale Capacity	Graduation Value				
1	0.0001,	0.0002,	0.0005,	0.001	
2	0.0001,	0.0002,	0.0005,	0.001,	0.002
3	0.0002,	0.0005,	0.001,	0.002	
5	0.0005,	0.001,	0.002,	0.005	
6	0.0005,	0.001,	0.002,	0.005	
10	0.0005,	0.001,	0.002,	0.005,	0.01
15	0.001,	0.002,	0.005,	0.01,	0.02
20	0.001,	0.002,	0.005,	0.01,	0.02
25	0.002,	0.005,	0.01,	0.02	
30	0.002,	0.005,	0.01,	0.02	
40	0.002,	0.005,	0.01,	0.02,	0.05
50	0.005,	0.01,	0.02,	0.05	
60	0.005,	0.01,	0.02,	0.05	
75	0.005,	0.01,	0.02,	0.05,	0.1
100	0.005,	0.01,	0.02,	0.05,	0.1
120	0.01,	0.02,	0.05,	0.1	
150	0.01,	0.02,	0.05,	0.1,	0.2
200	0.01,	0.02,	0.05,	0.1,	0.2
250	0.02,	0.05,	0.1,	0.2	
300	0.02,	0.05,	0.1,	0.2	
400	0.02,	0.05,	0.1,	0.2,	0.5
500	0.05,	0.1,	0.2,	0.5	
600	0.05,	0.1,	0.2,	0.5	
1000	0.05,	0.1,	0.2,	0.5,	1
1200	0.1,	0.2,	0.5,	1	
1500	0.1,	0.2,	0.5,	1,	2
2000	0.1,	0.2,	0.5,	1,	2
2500	0.2,	0.5,	1,	2	
3000	0.2,	0.5,	1,	2	
5000	0.5,	1,	2,	5	
6000	0.5,	1,	2,	5	
10000	0.5,	1,	2,	5,	10
12000	1,	2,	5,	10	
15000	1,	2,	5,	10,	20
20000	1,	2,	5,	10,	20
30000	2,	5,	10,	20	
50000	5,	10,	20,	50	
60000	5,	10,	20,	50	
100000	5,	10,	20,	50	

LIMITED WARRANTY

Ohaus products are warranted against defects in materials and workmanship from the date of delivery through the duration of the warranty period. During the warranty period Ohaus will repair, or, at its option, replace any component(s) that proves to be defective at no charge, provided that the product is returned, freight prepaid, to Ohaus.

This warranty does not apply if the product has been damaged by accident or misuse, exposed to radioactive or corrosive materials, has foreign material penetrating to the inside of the product, or as a result of service or modification by other than Ohaus. In lieu of a properly returned warranty registration card, the warranty period shall begin on the date of shipment to the authorized dealer. No other express or implied warranty is given by Ohaus Corporation. Ohaus Corporation shall not be liable for any consequential damages.

As warranty legislation differs from state to state and country to country, please contact Ohaus or your local Ohaus dealer for further details.



Ohaus Corporation
19A Chapin Road,
P.O. Box 2033
Pine Brook, NJ 07058, USA
Tel: (973) 377-9000
Fax: (973) 593-0359
www.ohaus.com

With offices worldwide.



* 8 0 2 5 1 0 3 1 *

P/N 80251031 C © Ohaus Corporation 2005, all rights reserved.

Printed in China